

ALEX

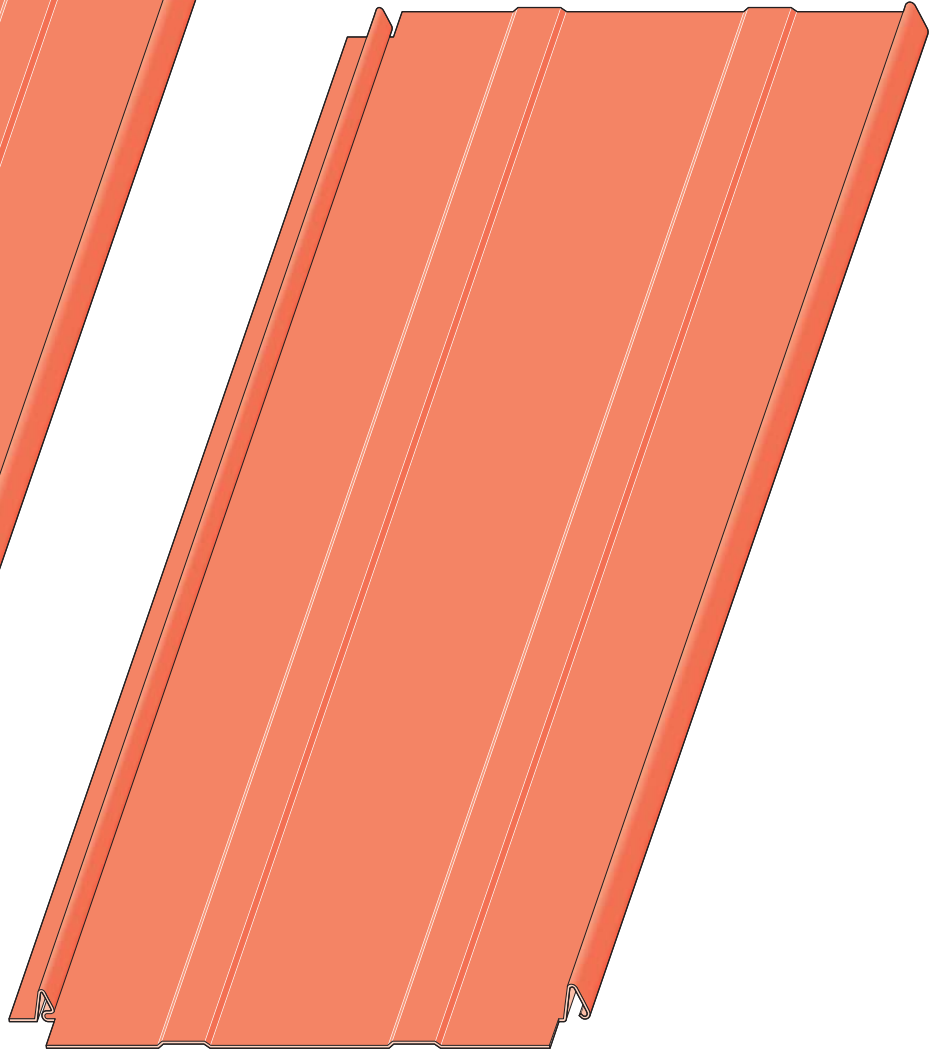

OSKAR

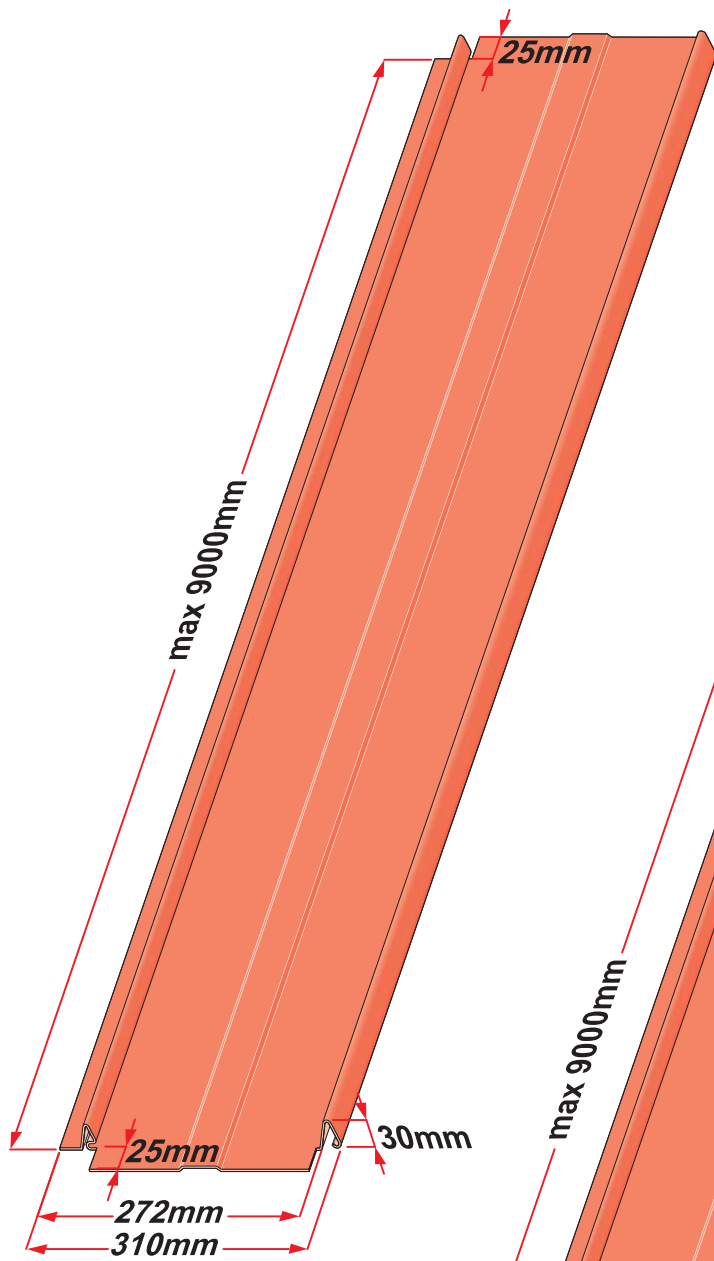



ALEX

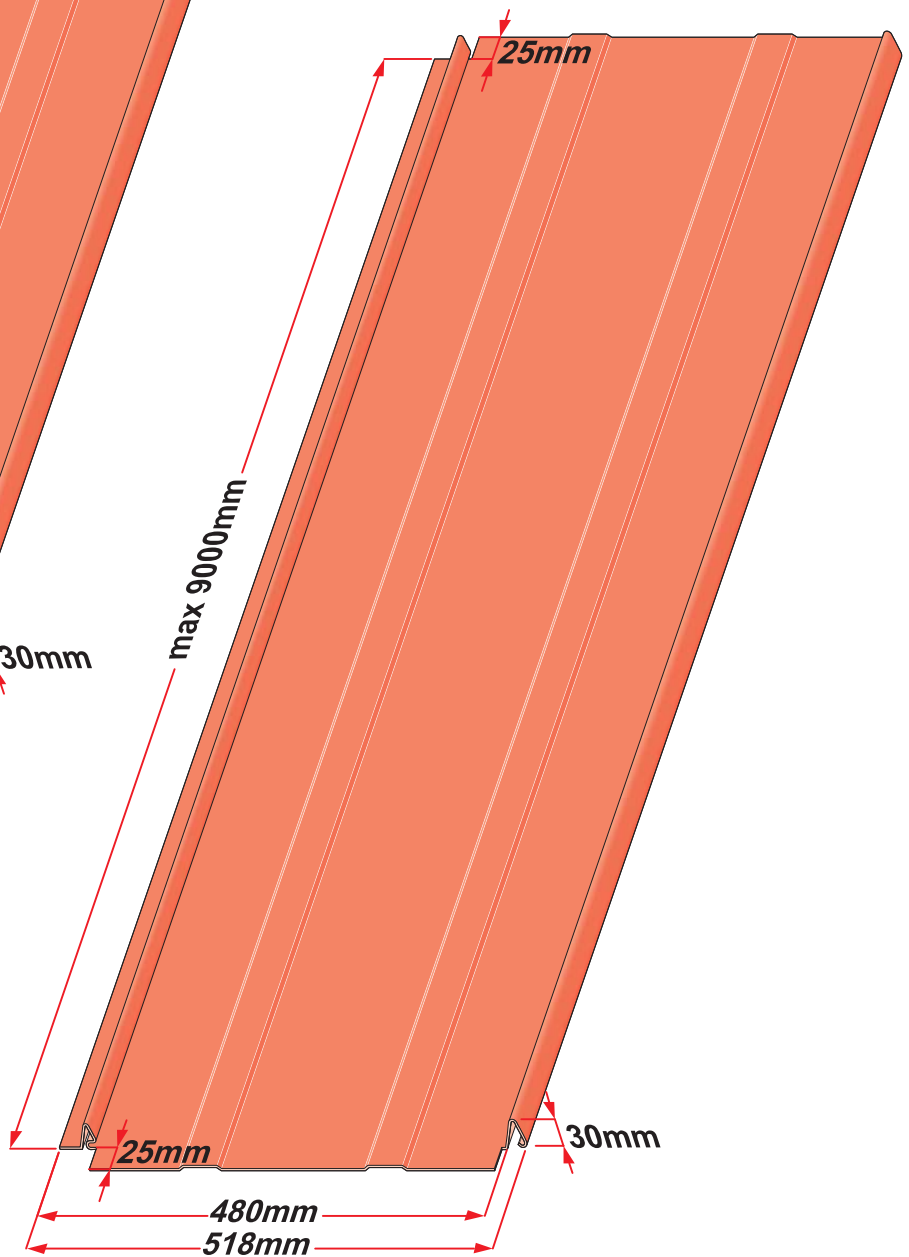

OSKAR

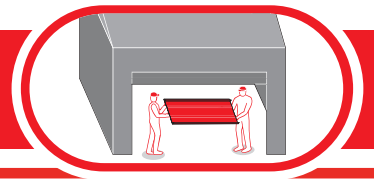

1

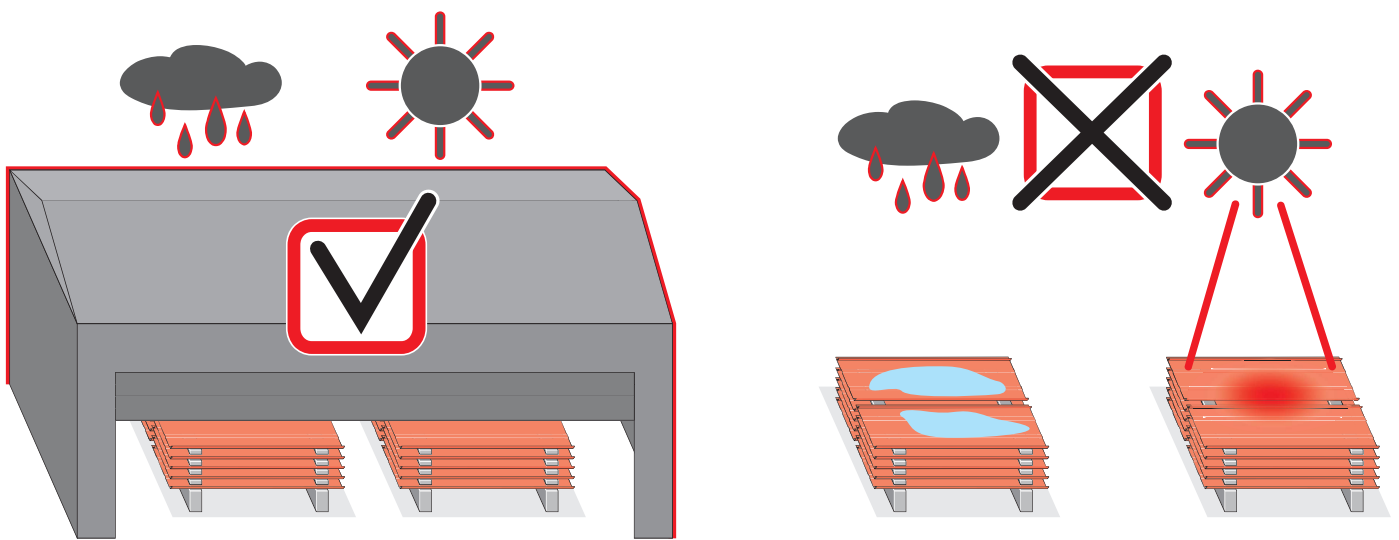
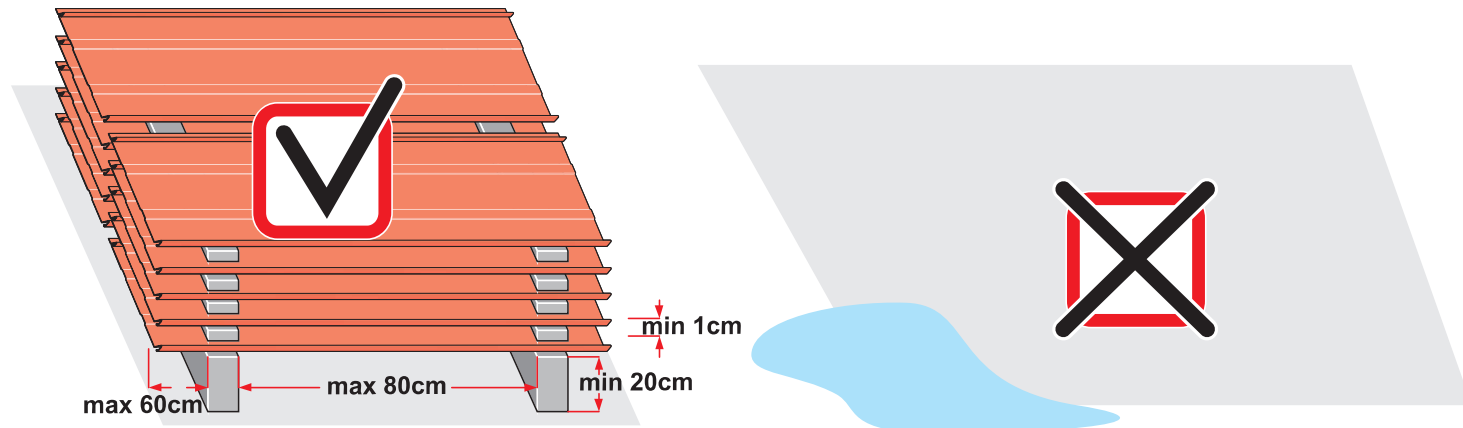
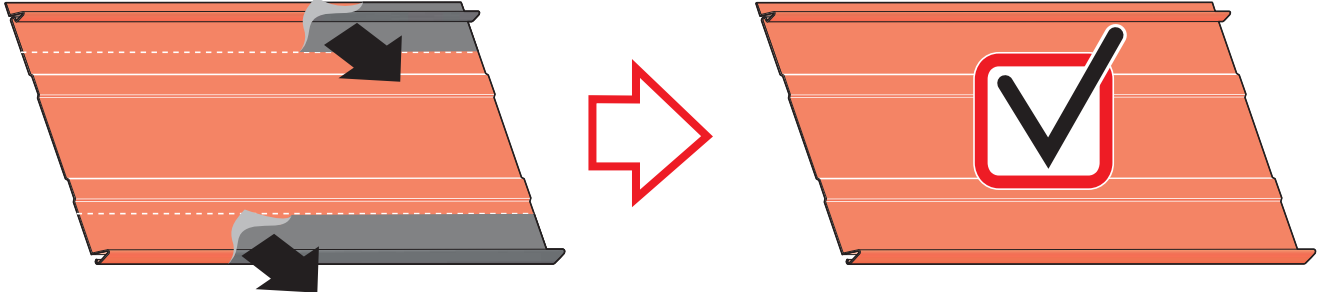

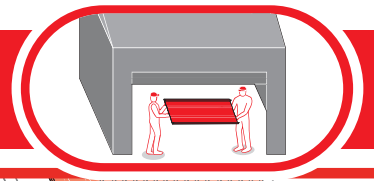

2

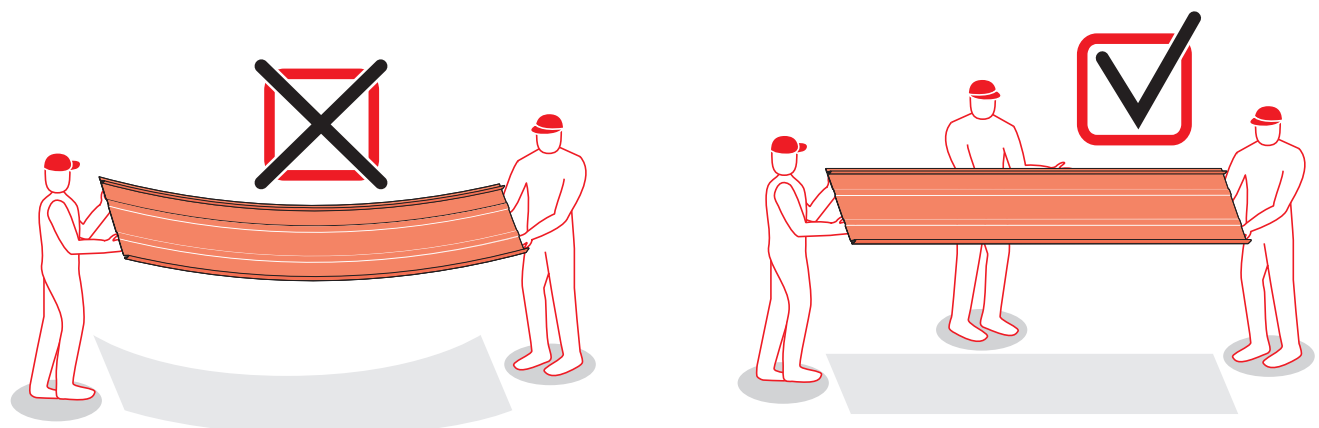
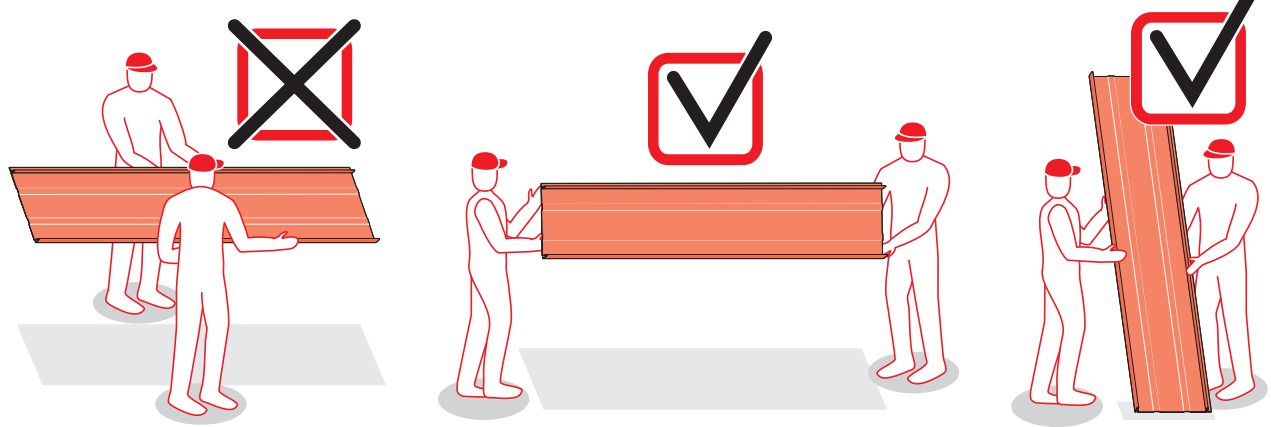
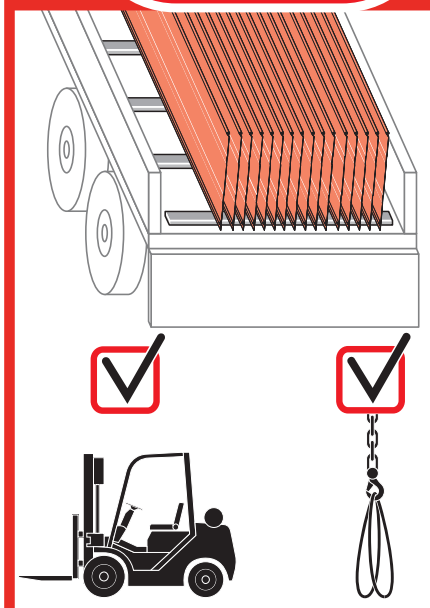
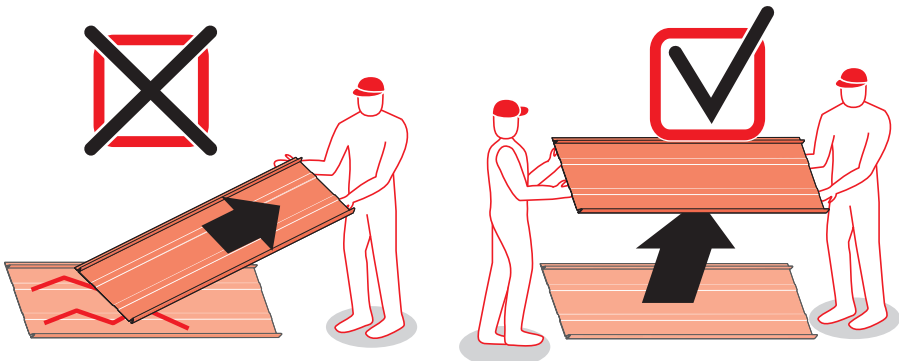

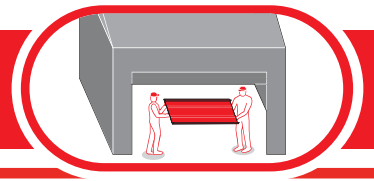

3

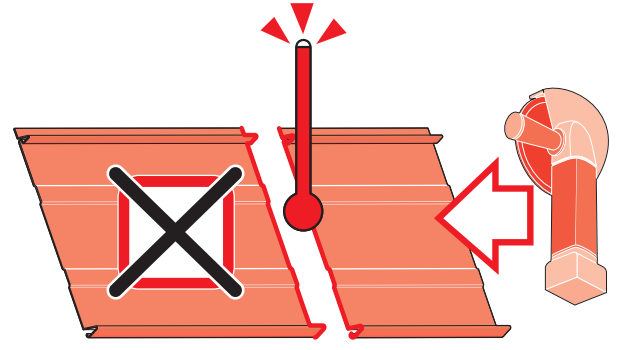
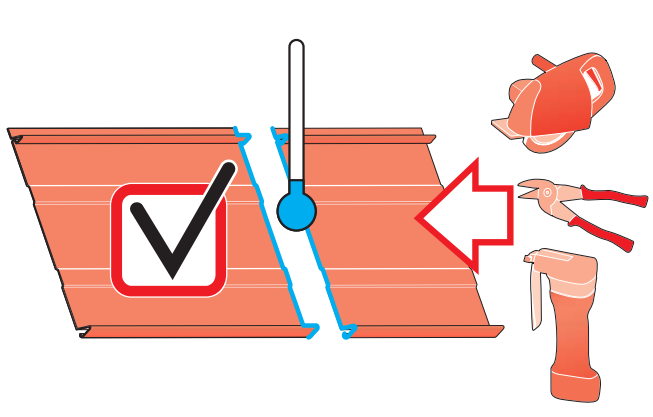

4

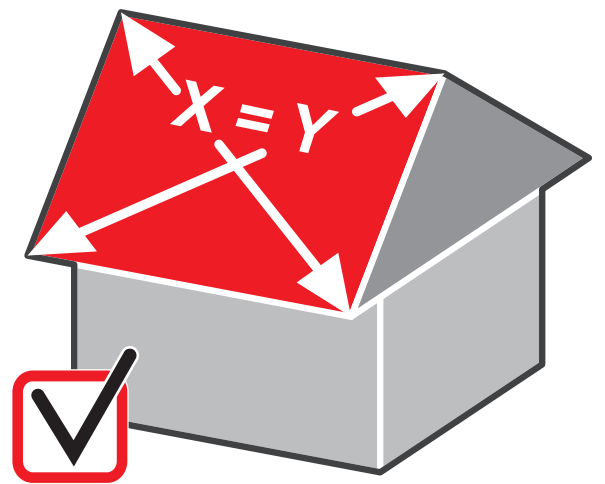
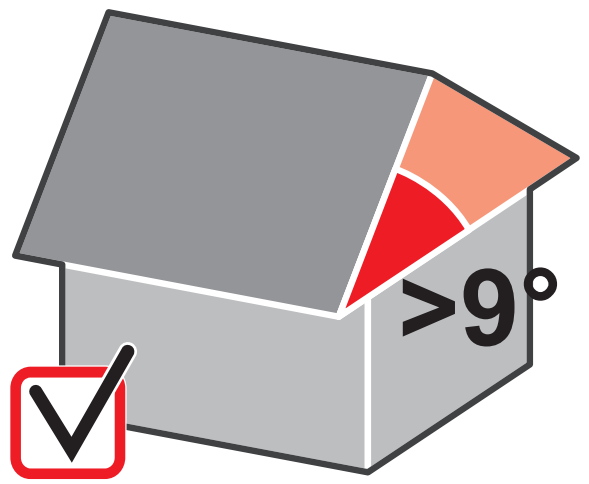

5

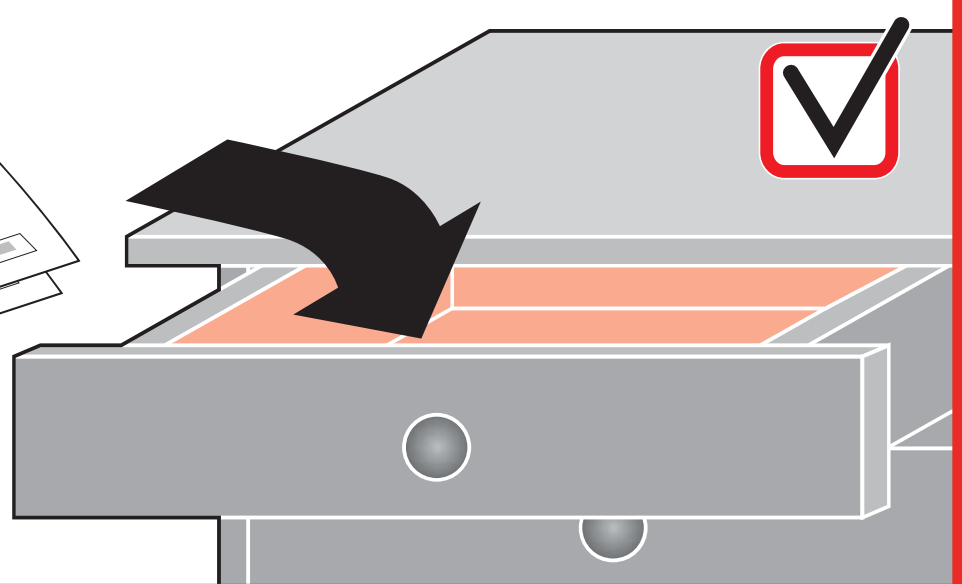
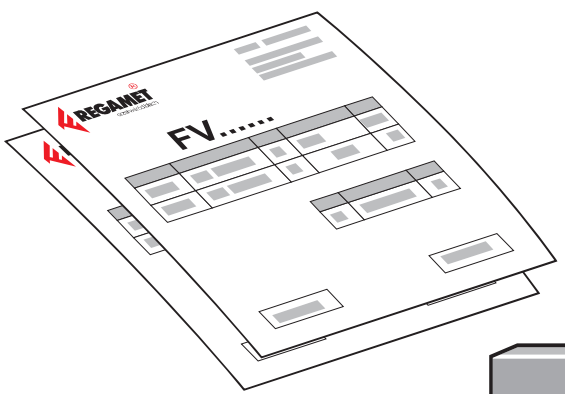

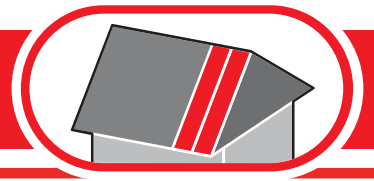

6

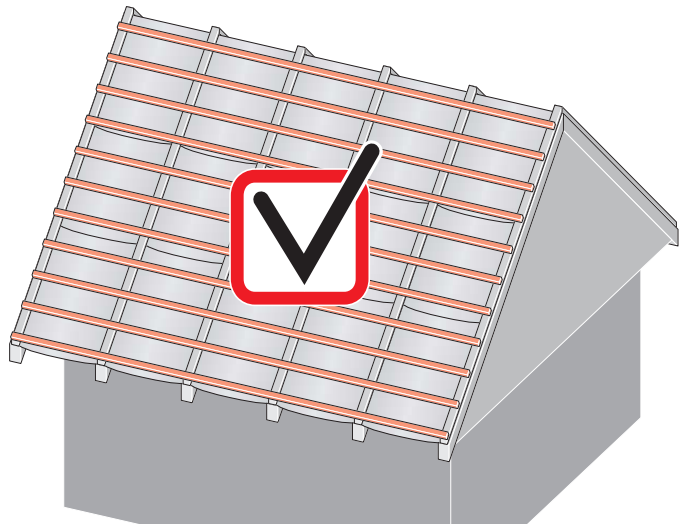
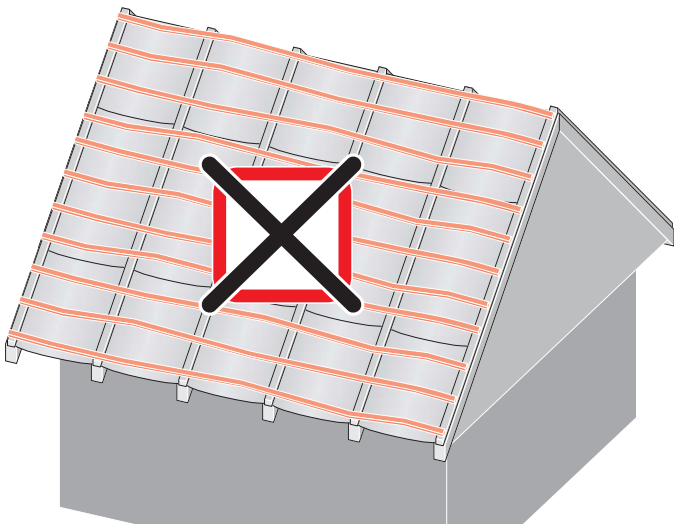
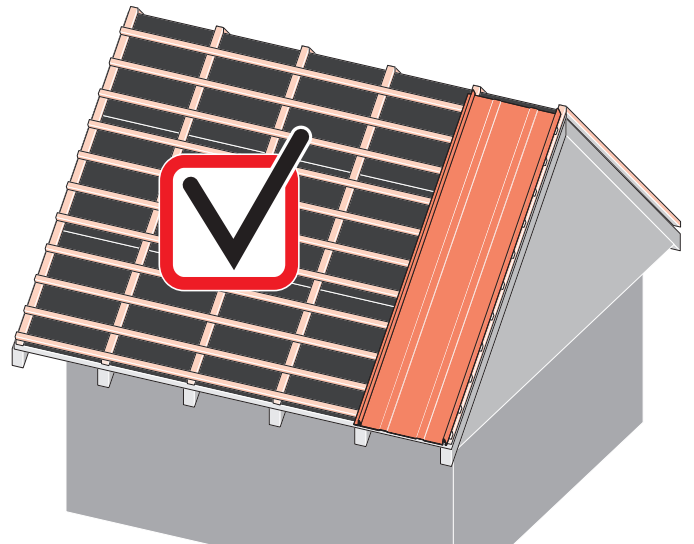
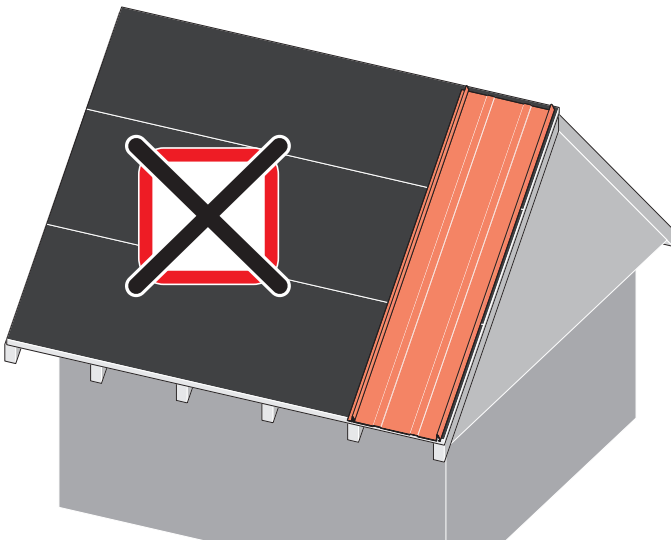
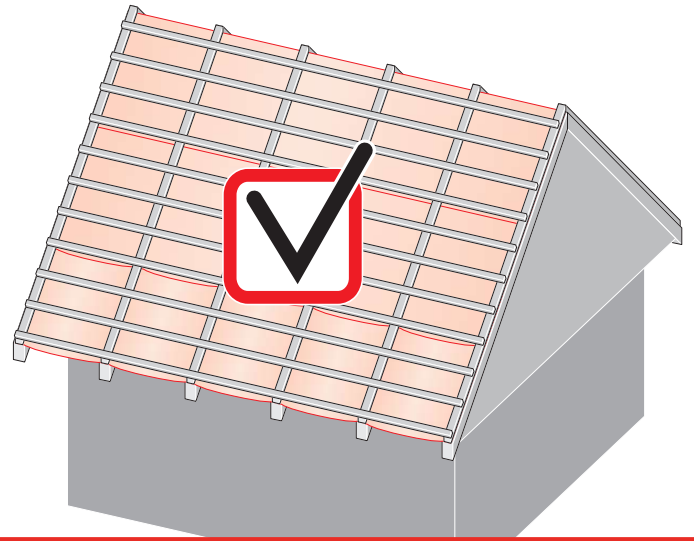
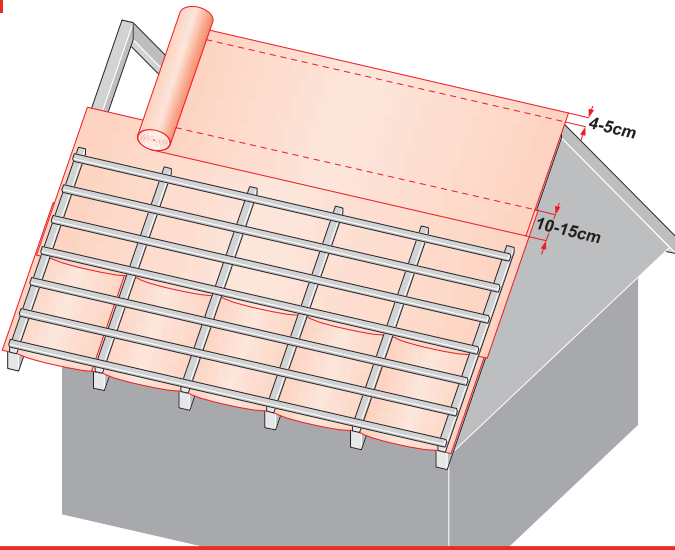

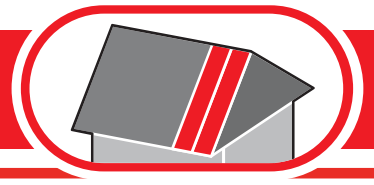

7

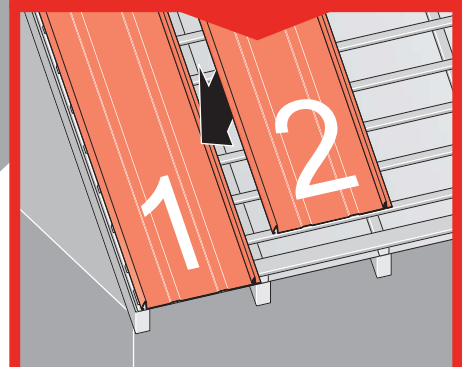
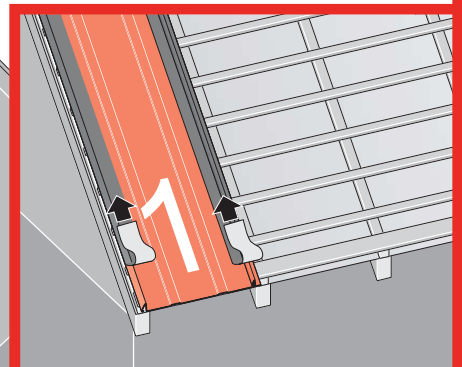
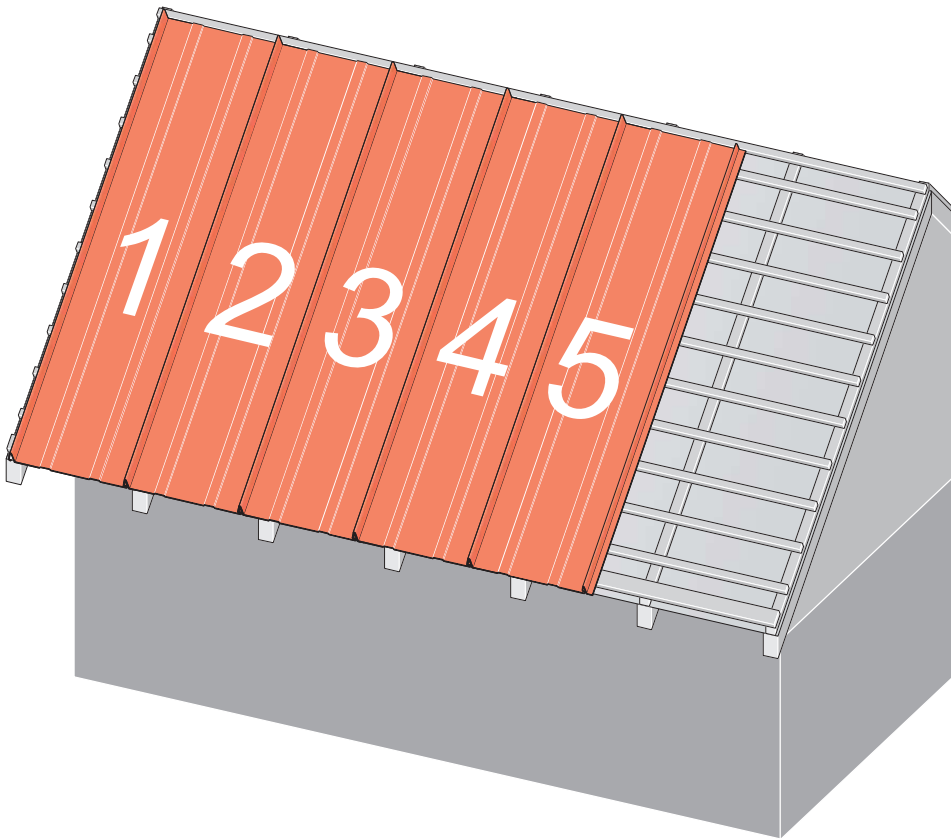
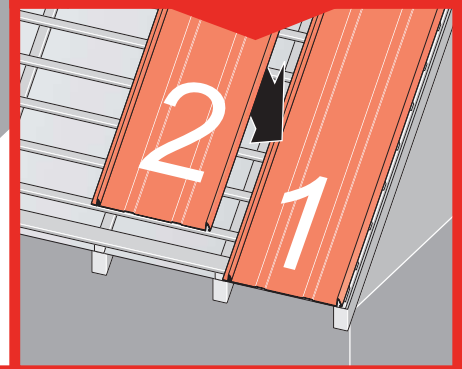
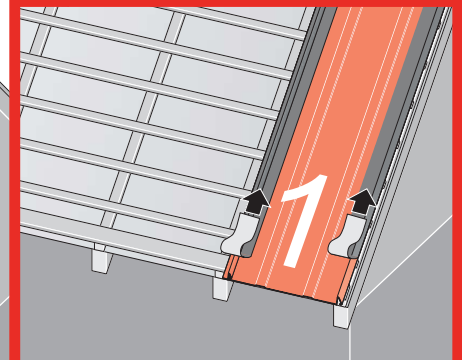
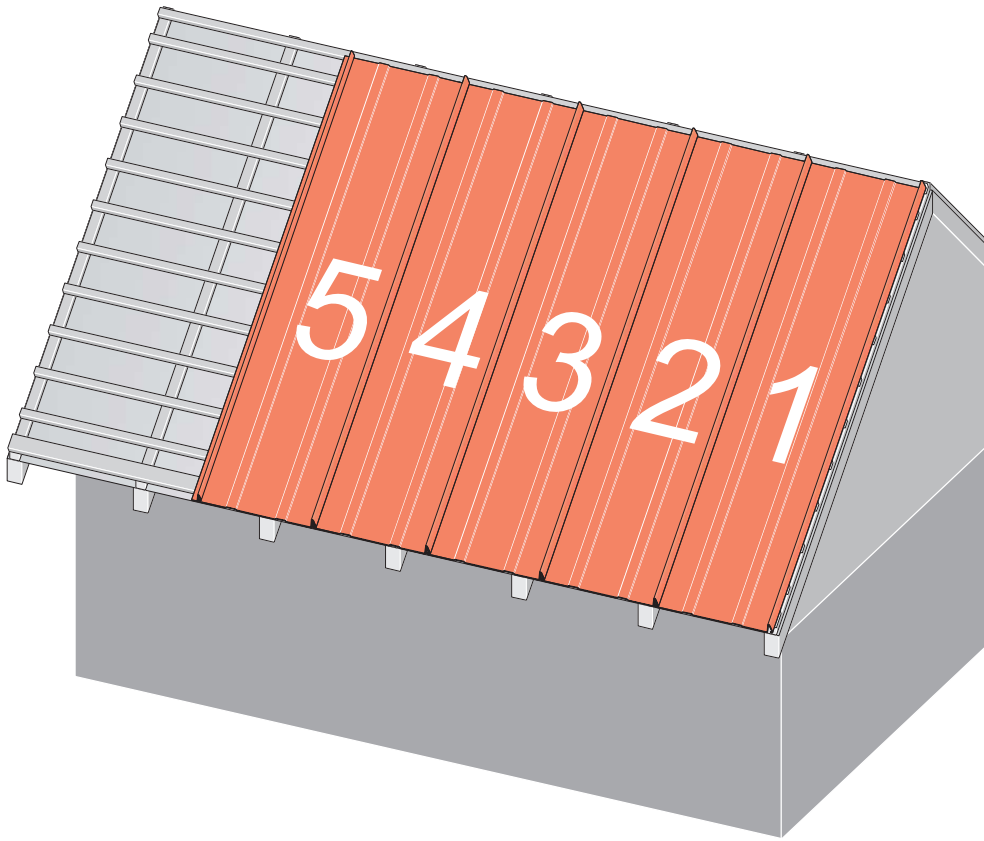

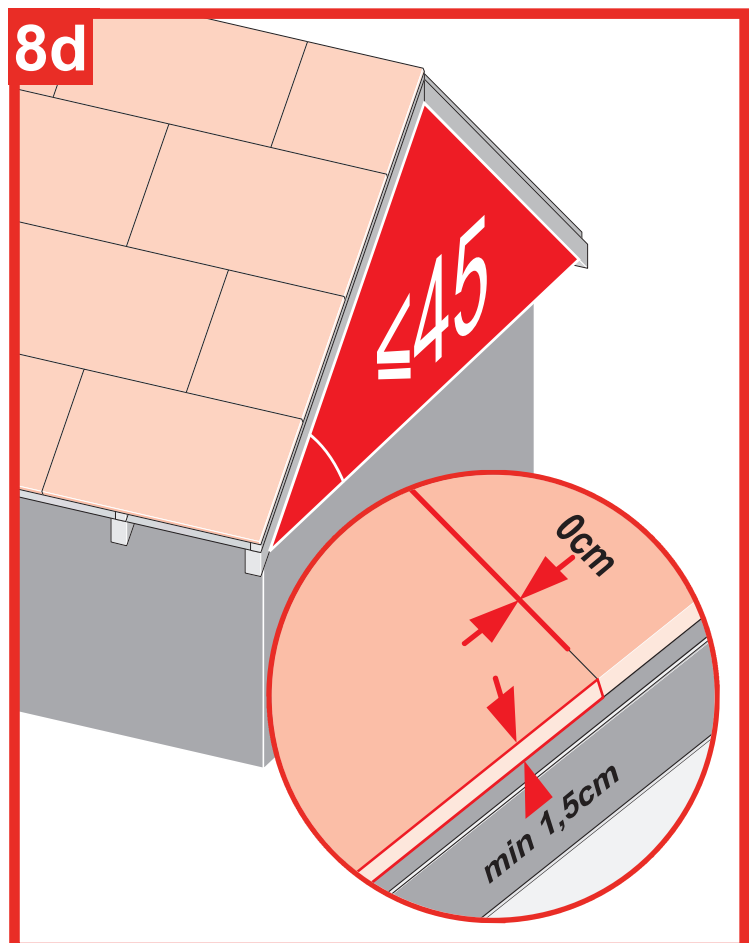
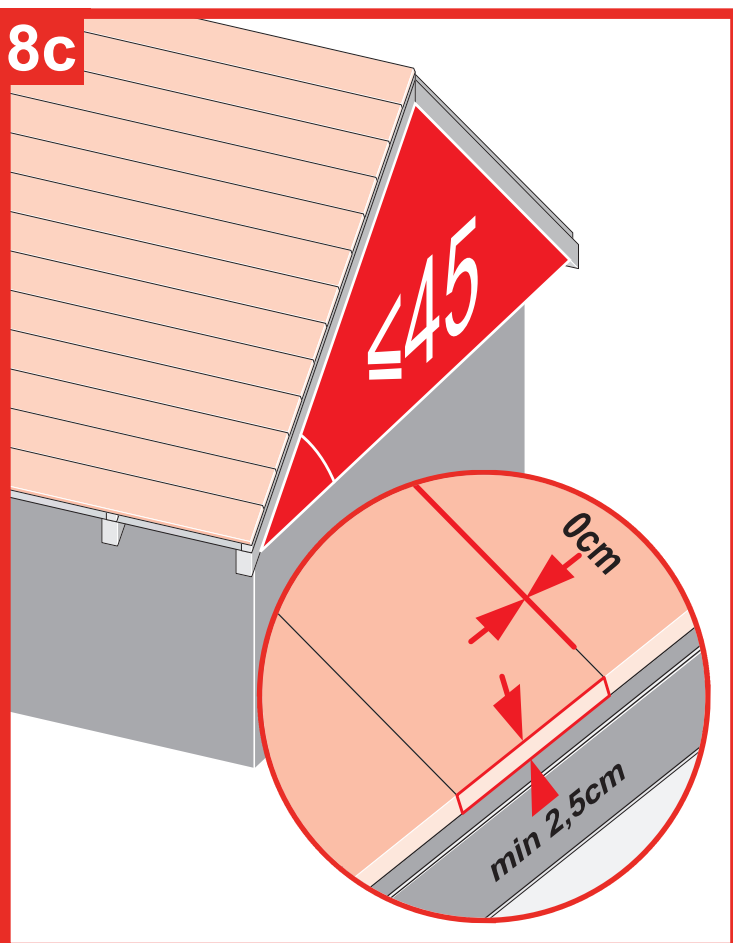
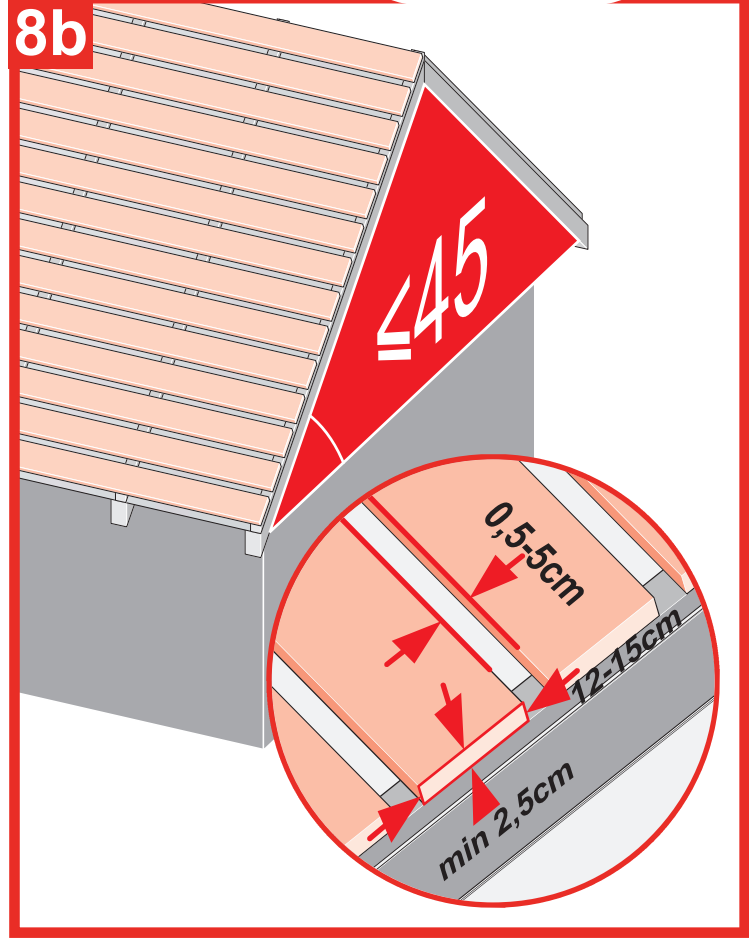
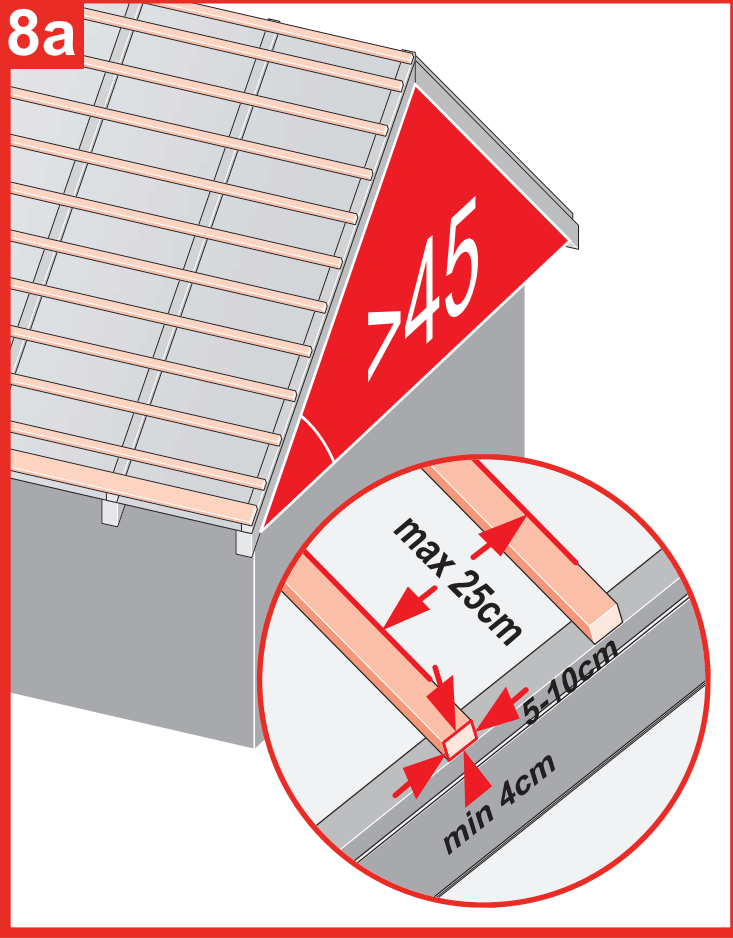
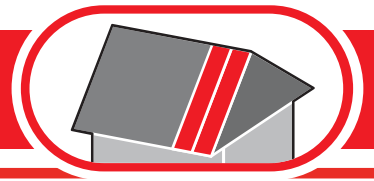

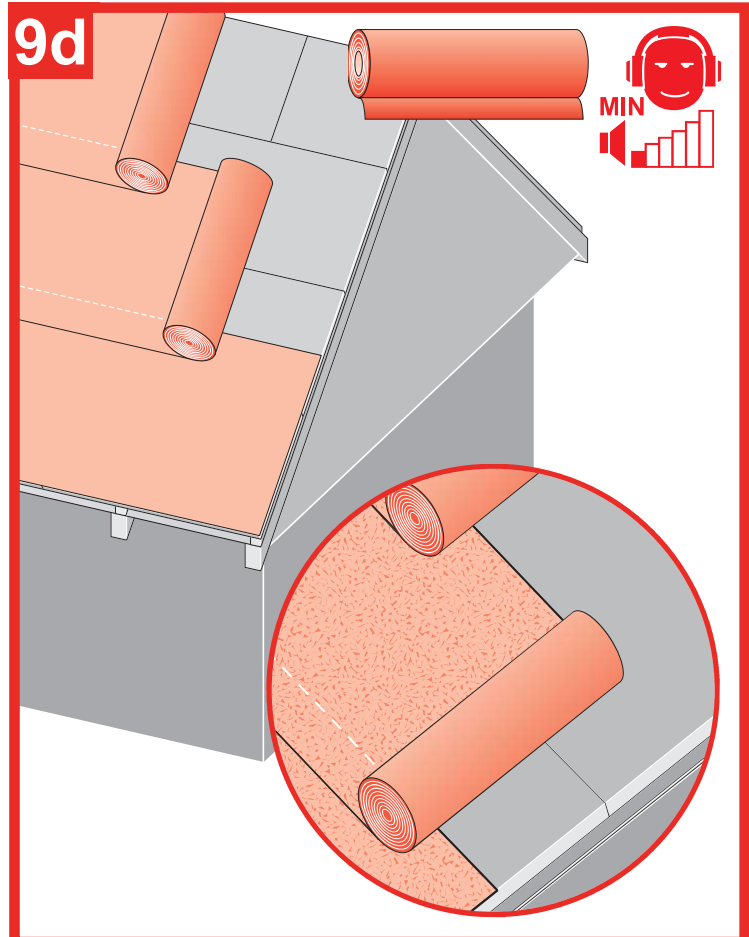
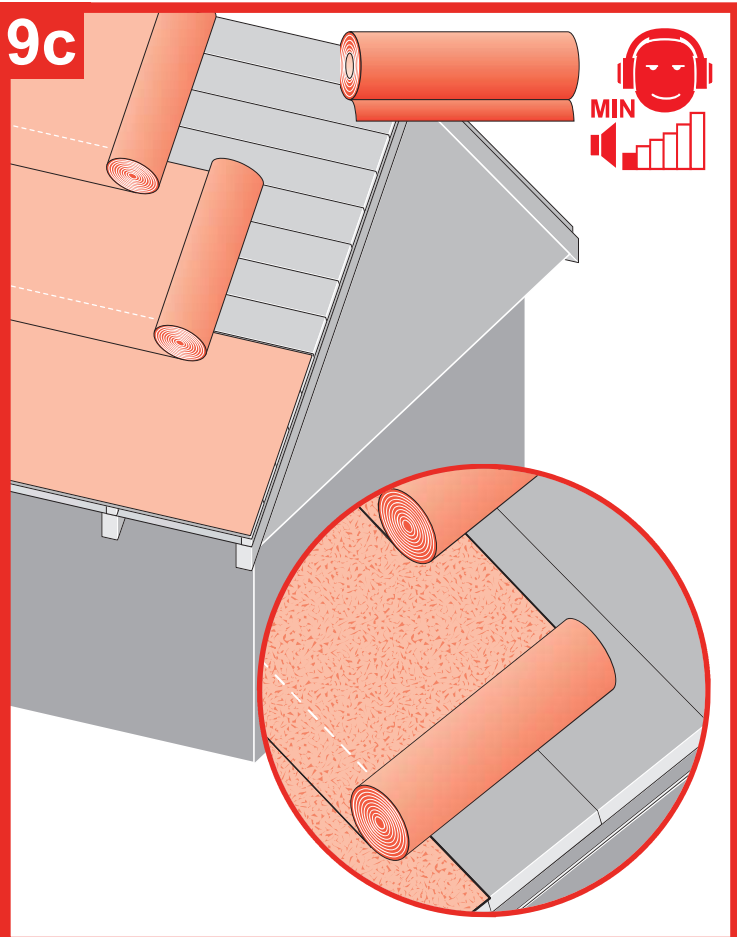
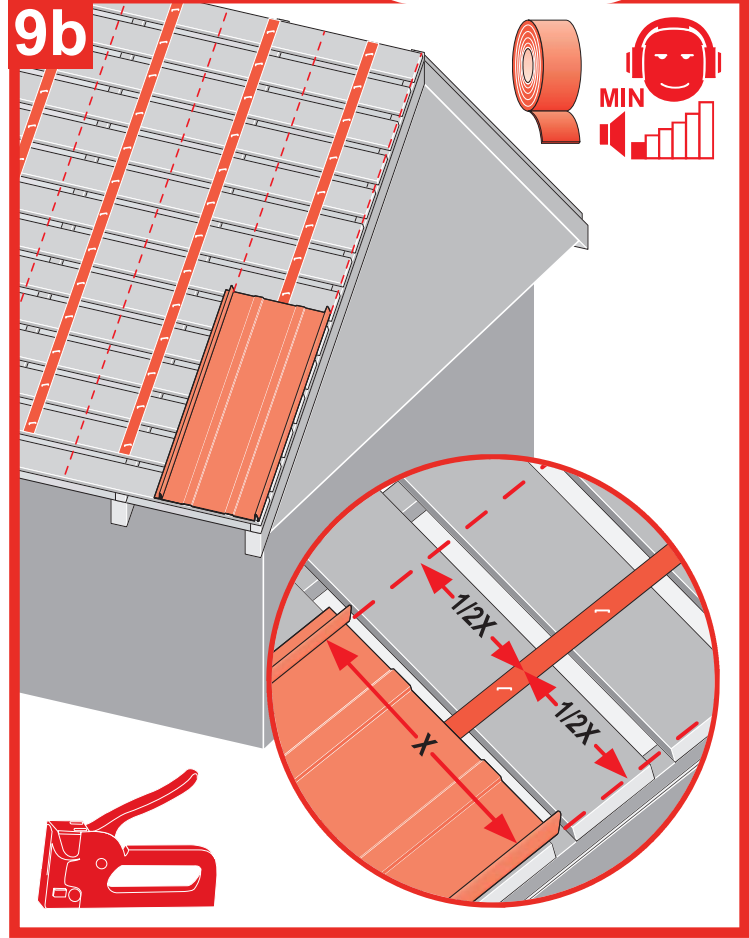
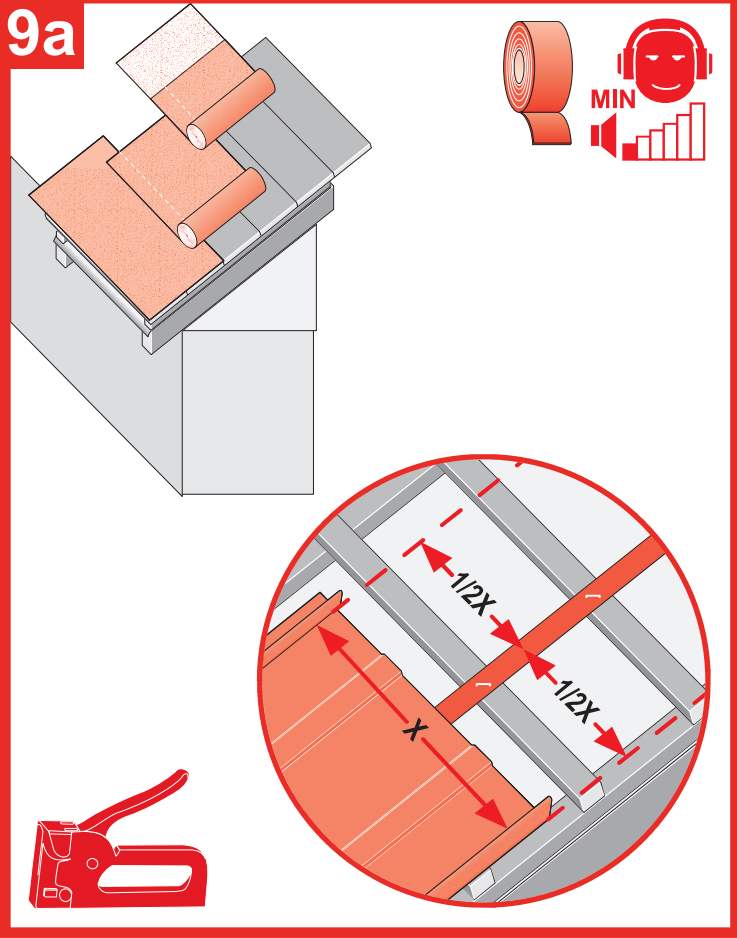
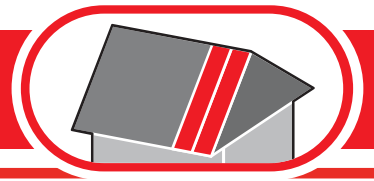

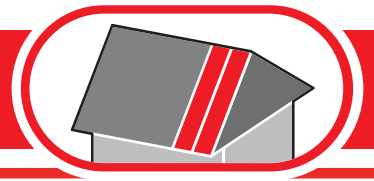

10

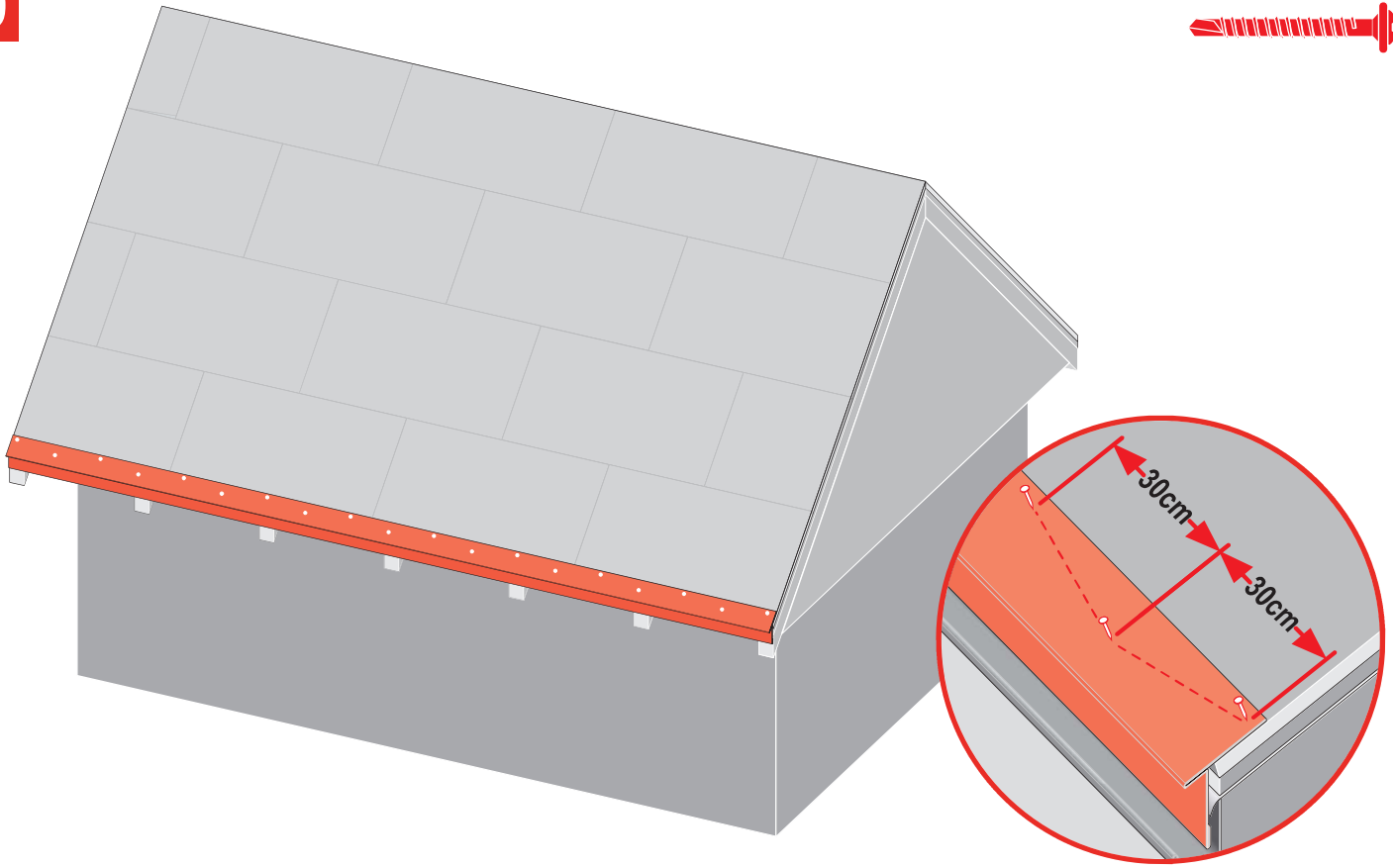

11



A=B=.....cm

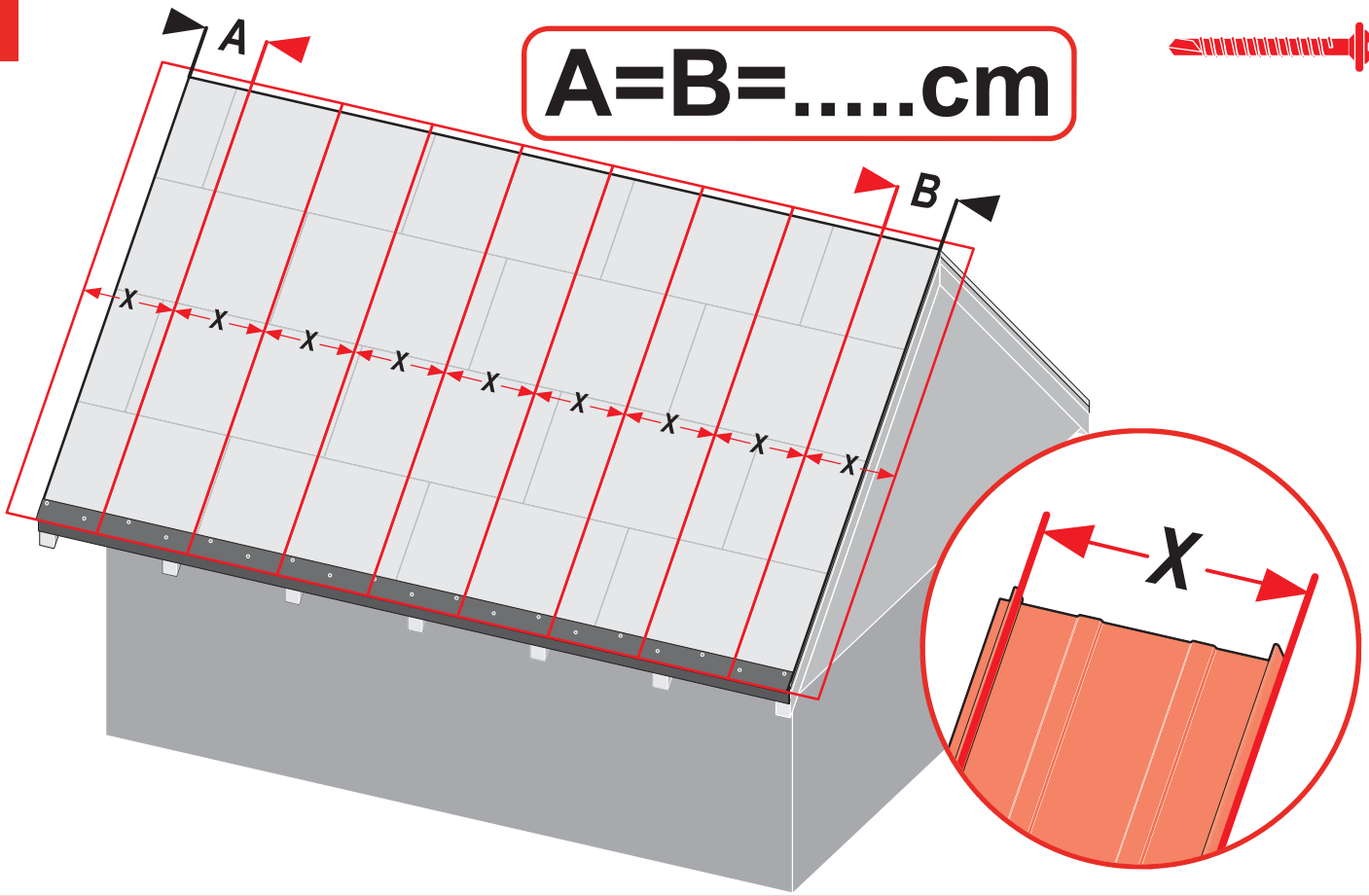

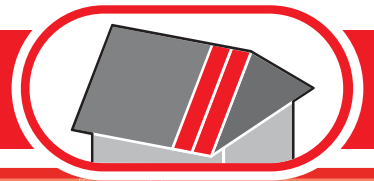

12

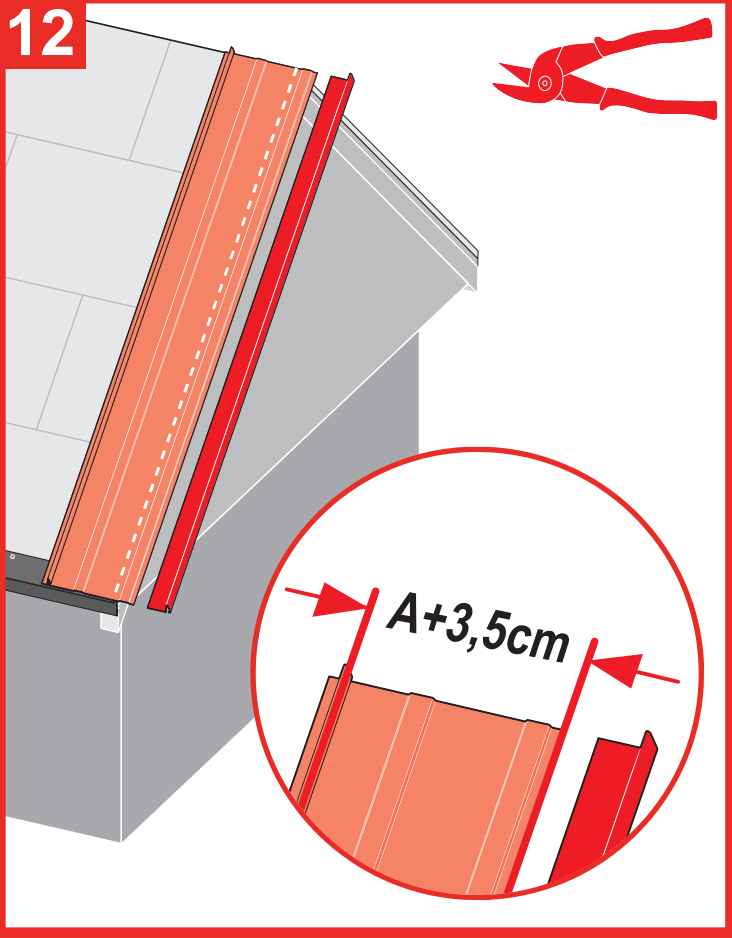

a

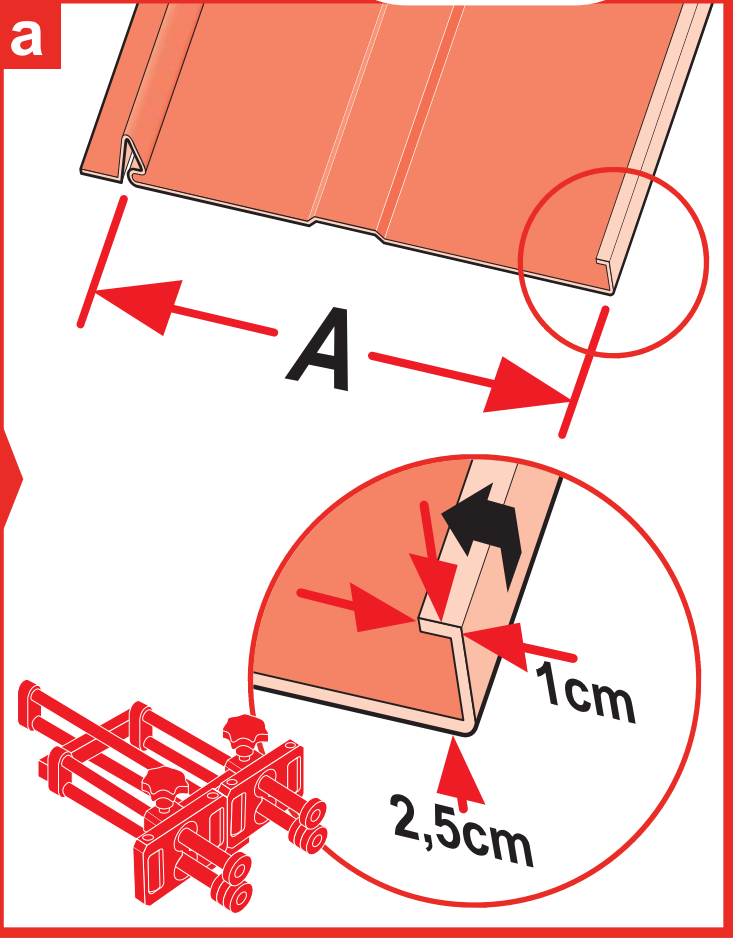

b

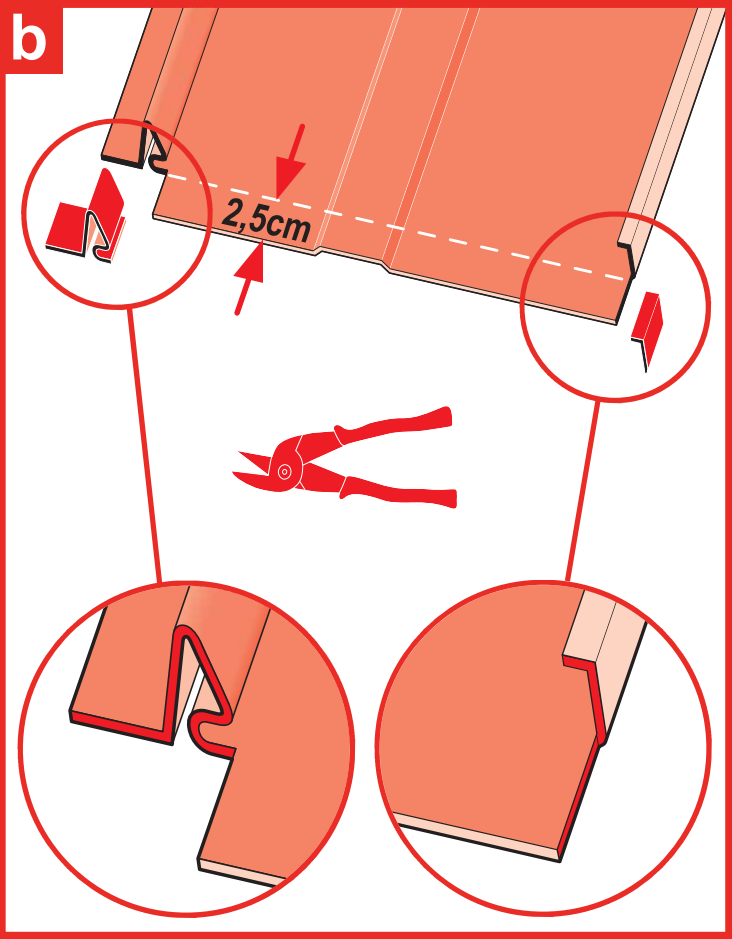

c

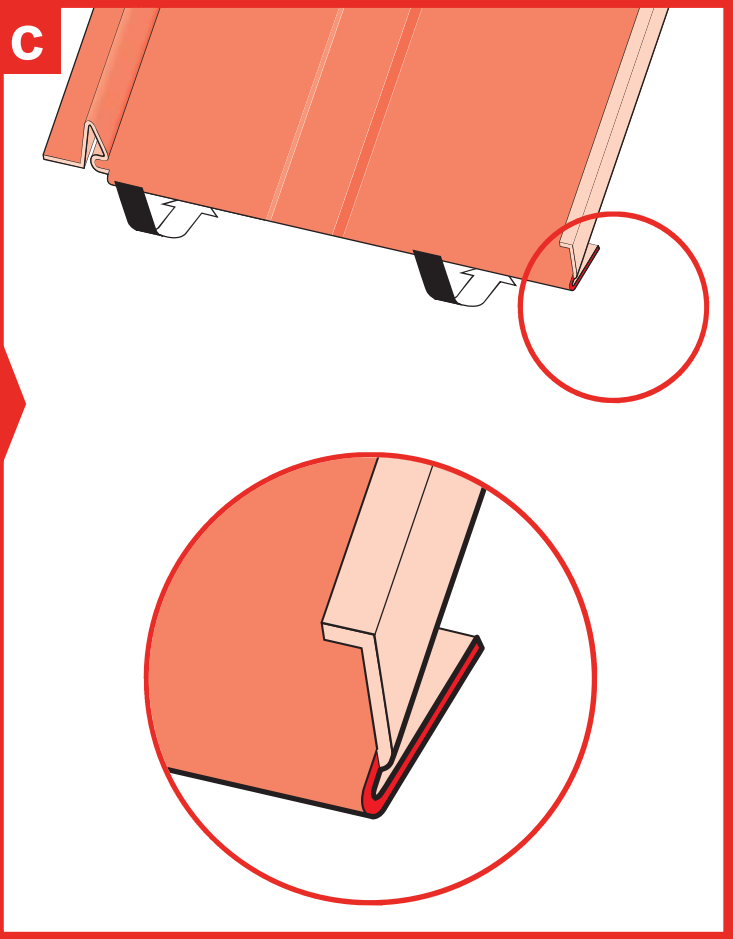

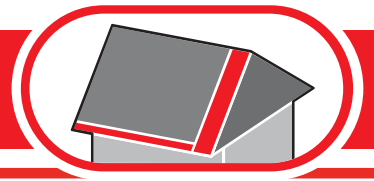

13

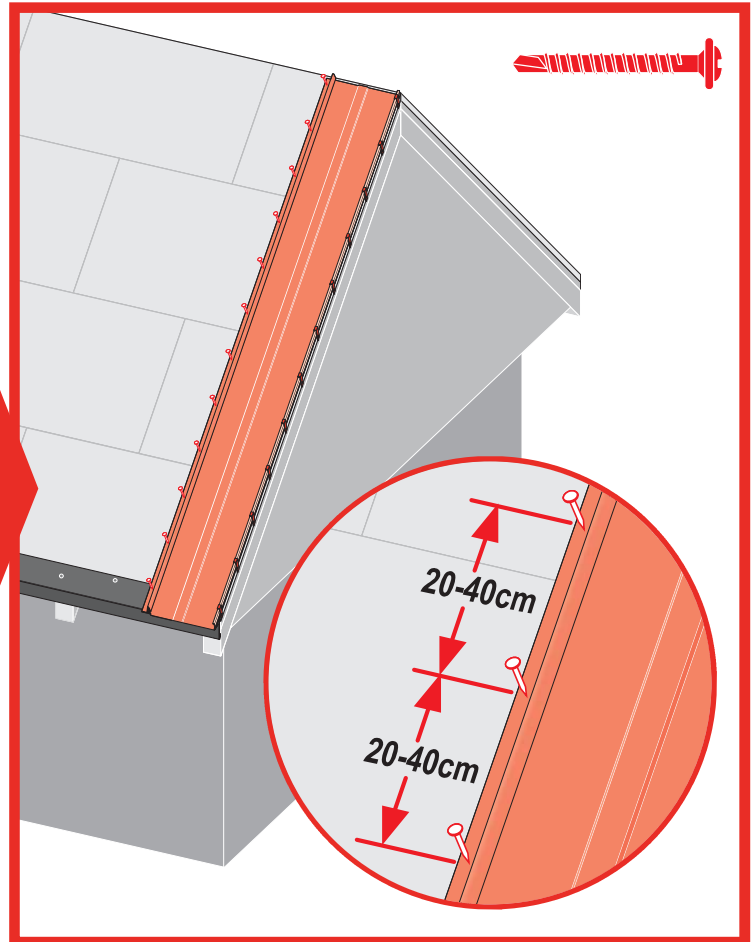
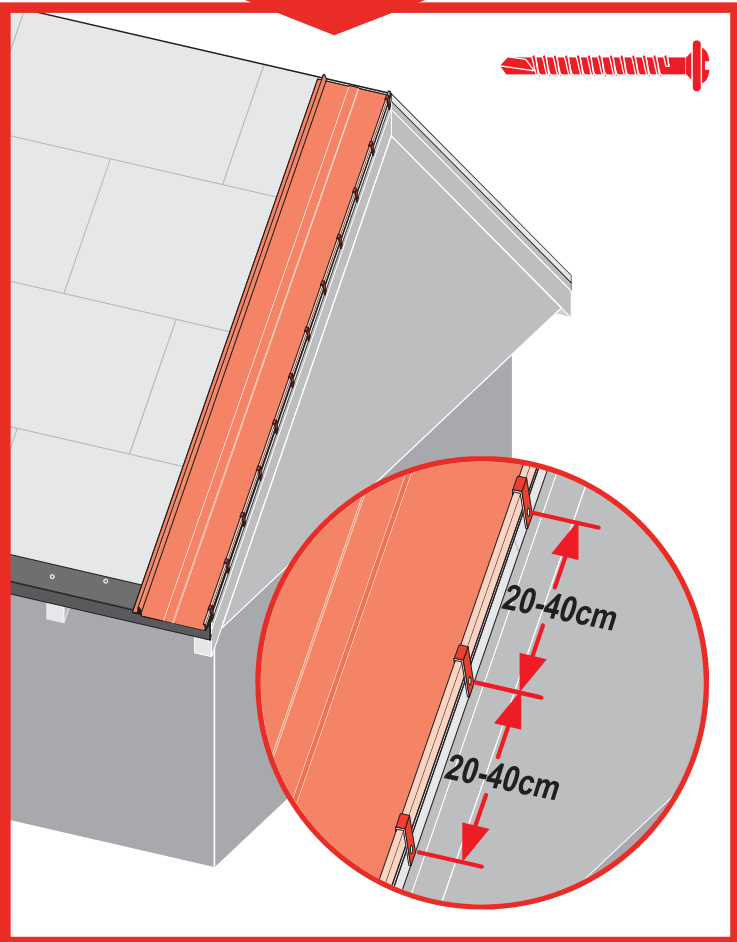
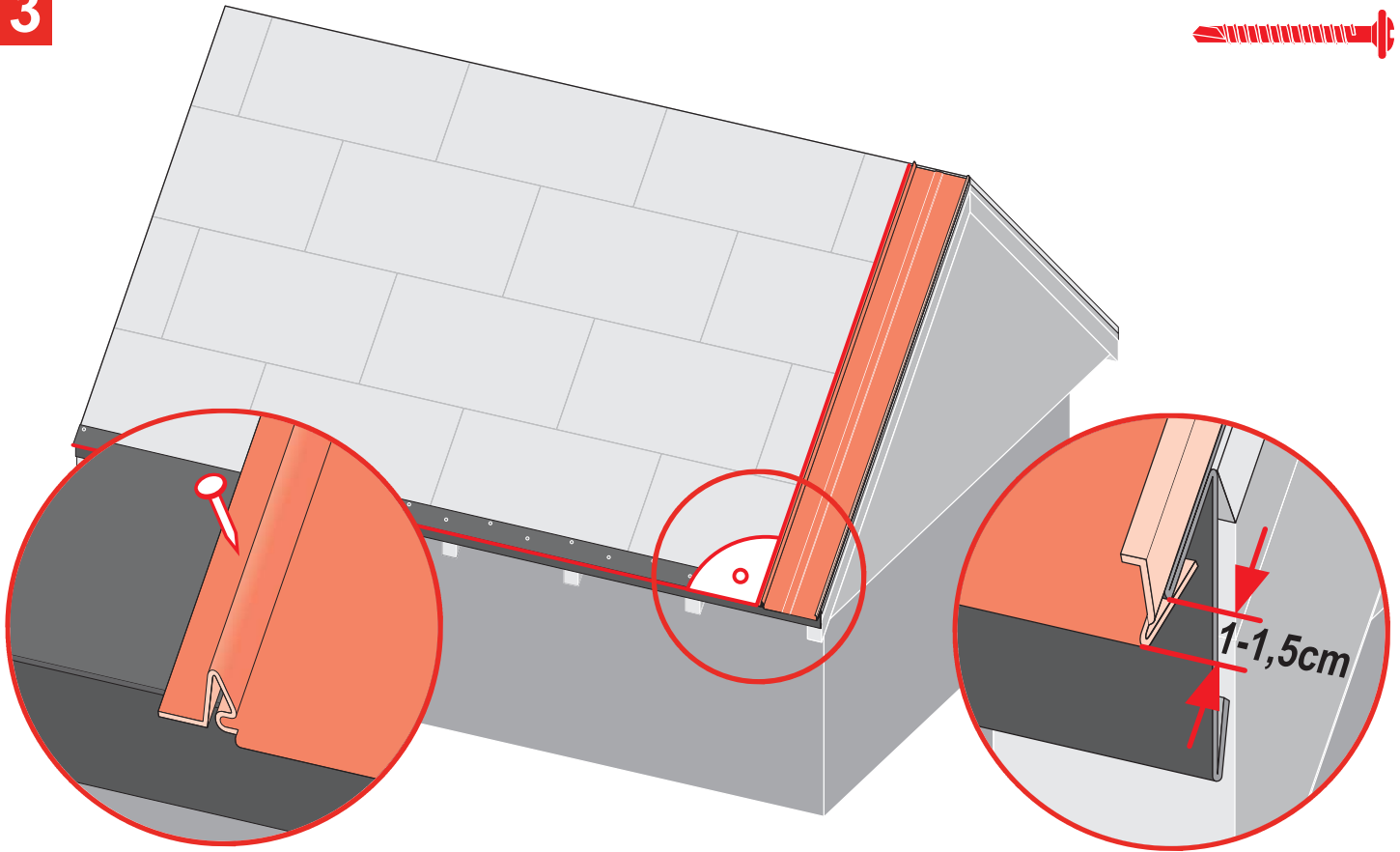

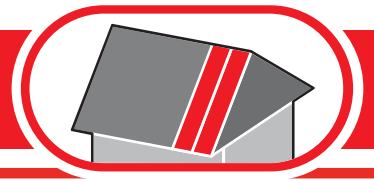

14

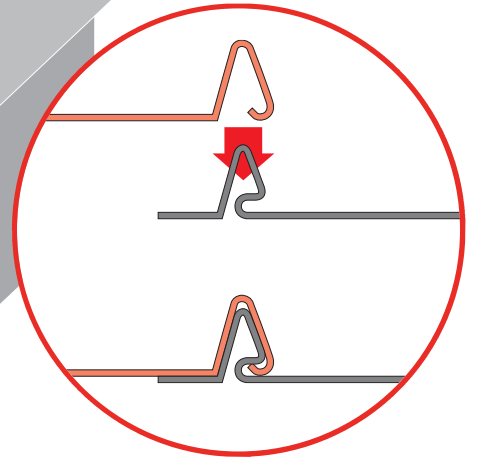
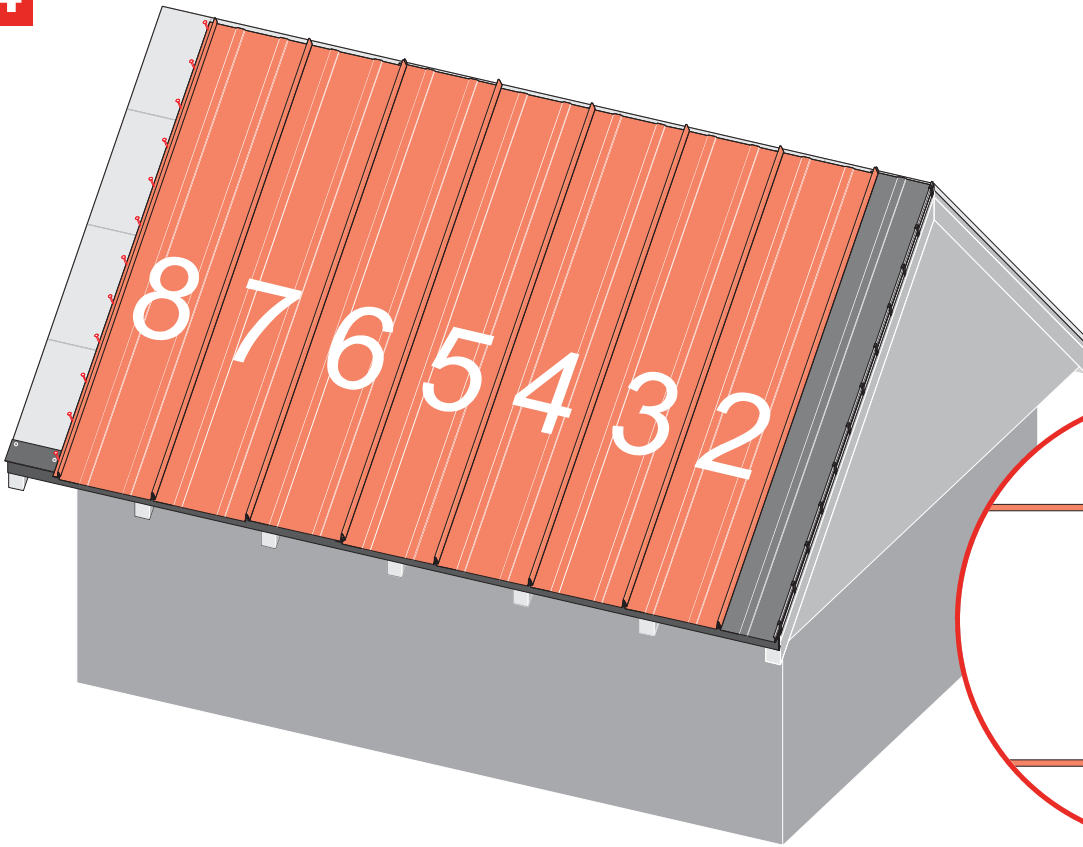

15

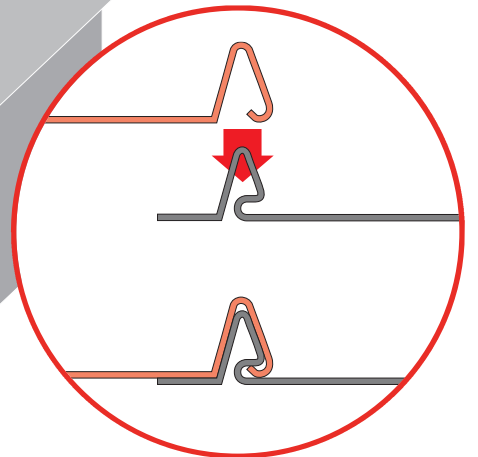
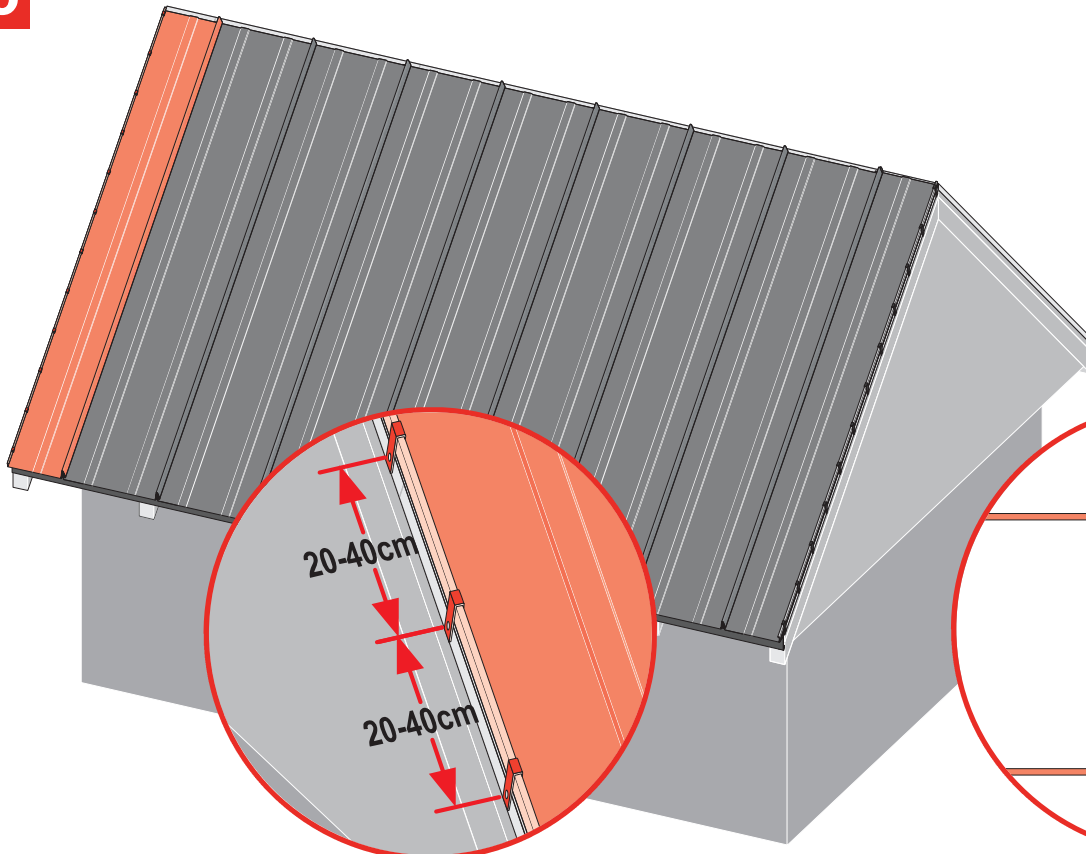

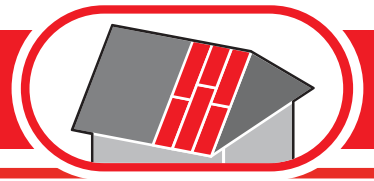

16

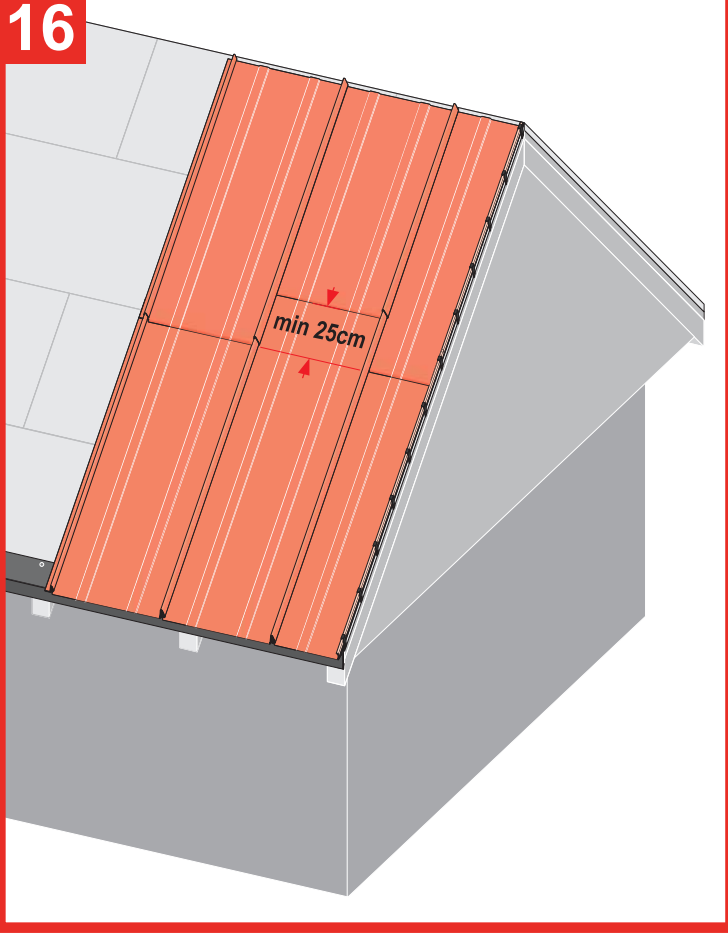

a

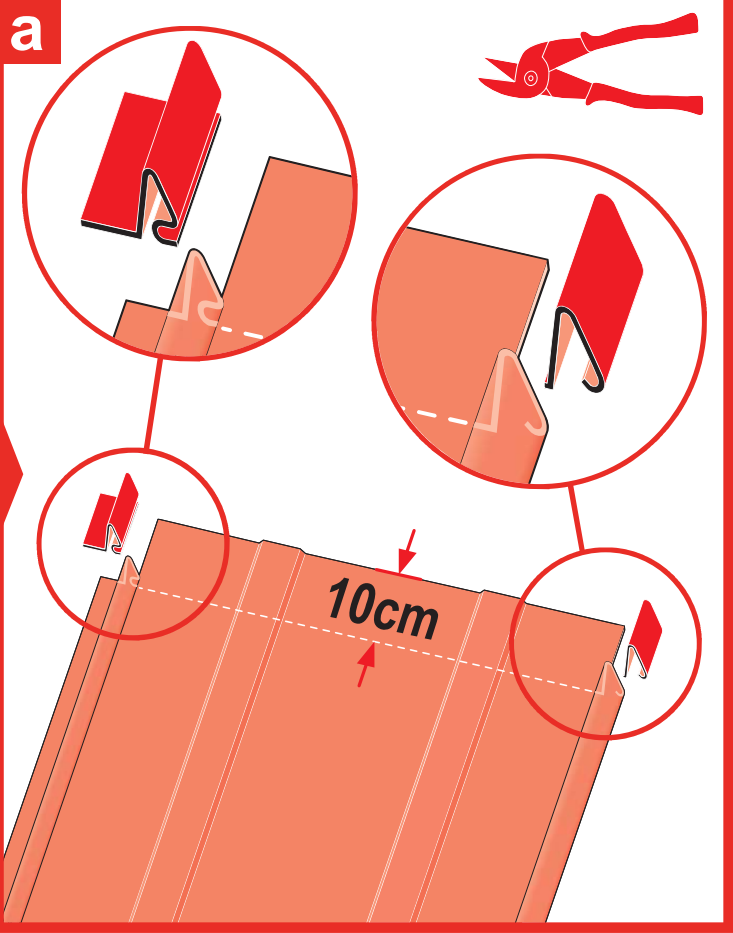

b

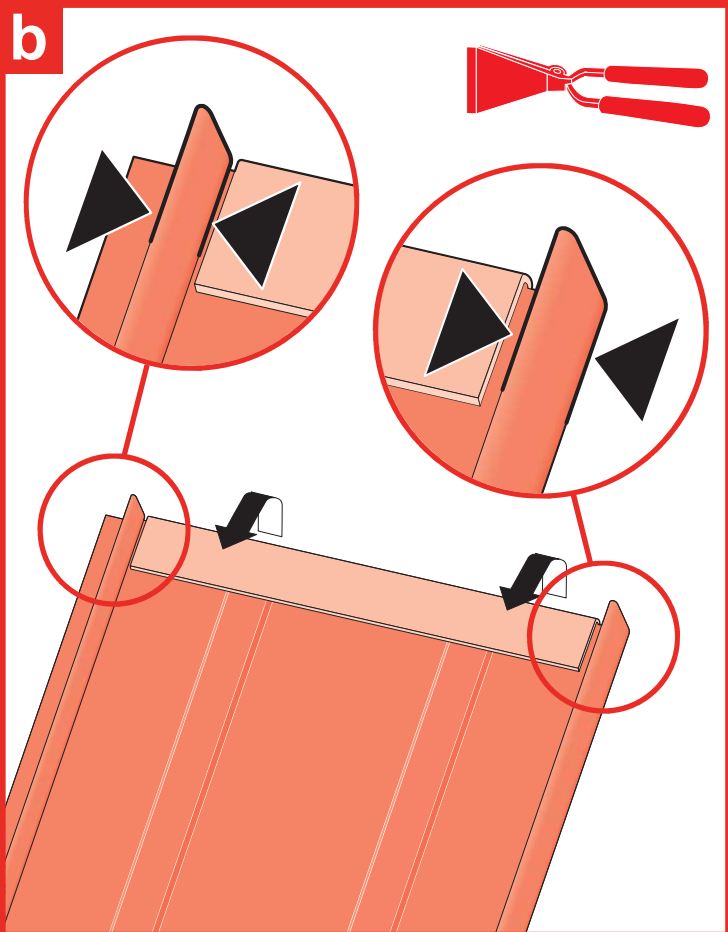

c

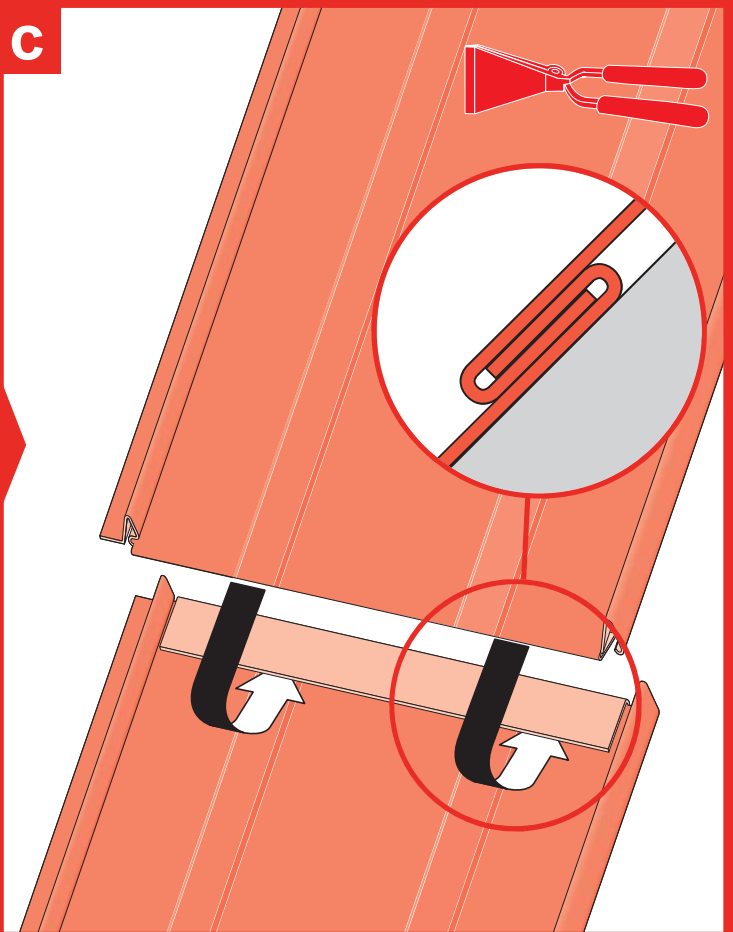

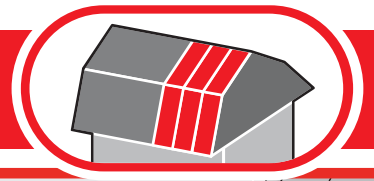

17

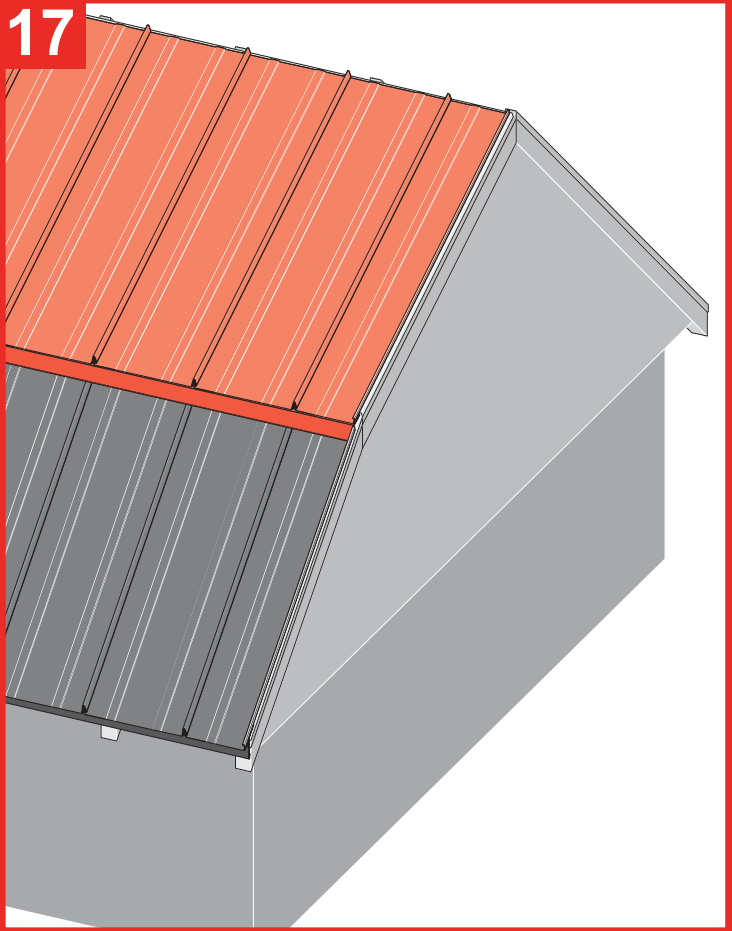

a

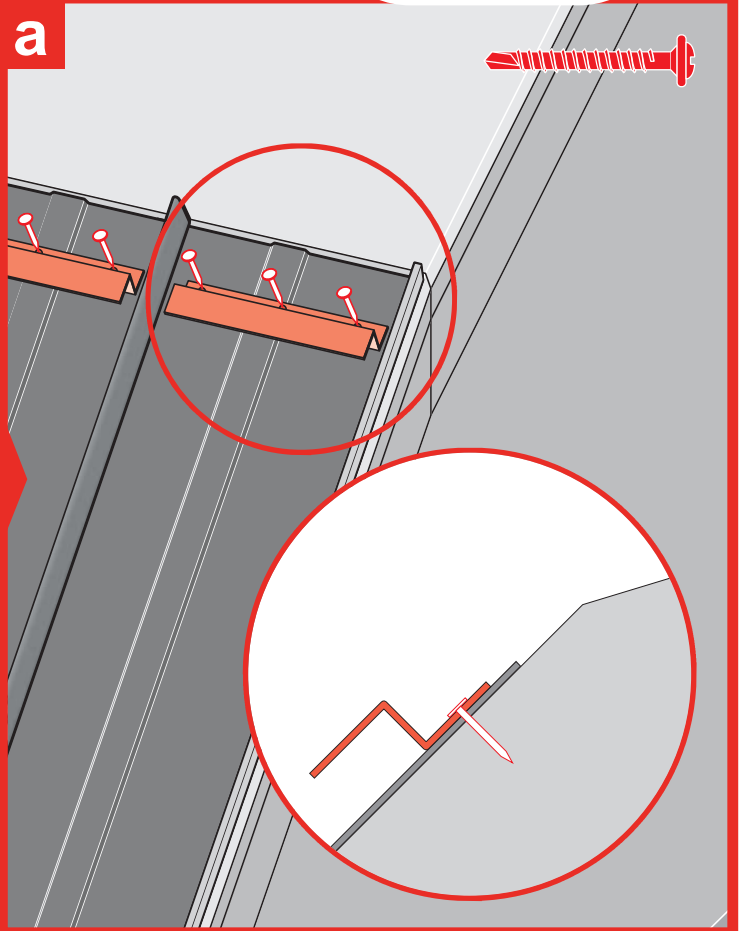

b

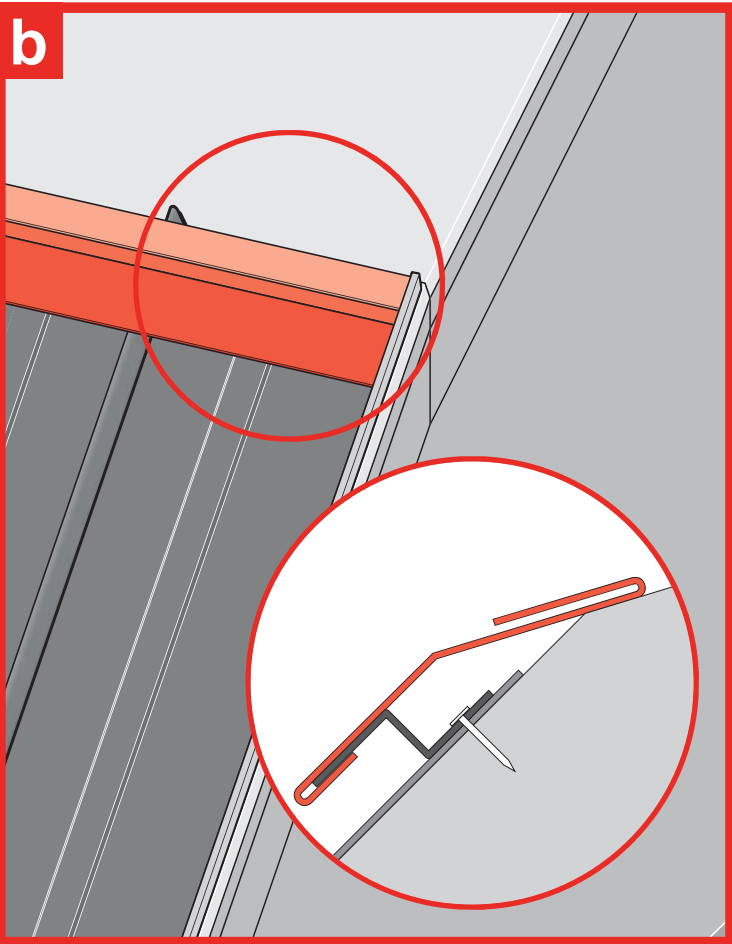

c

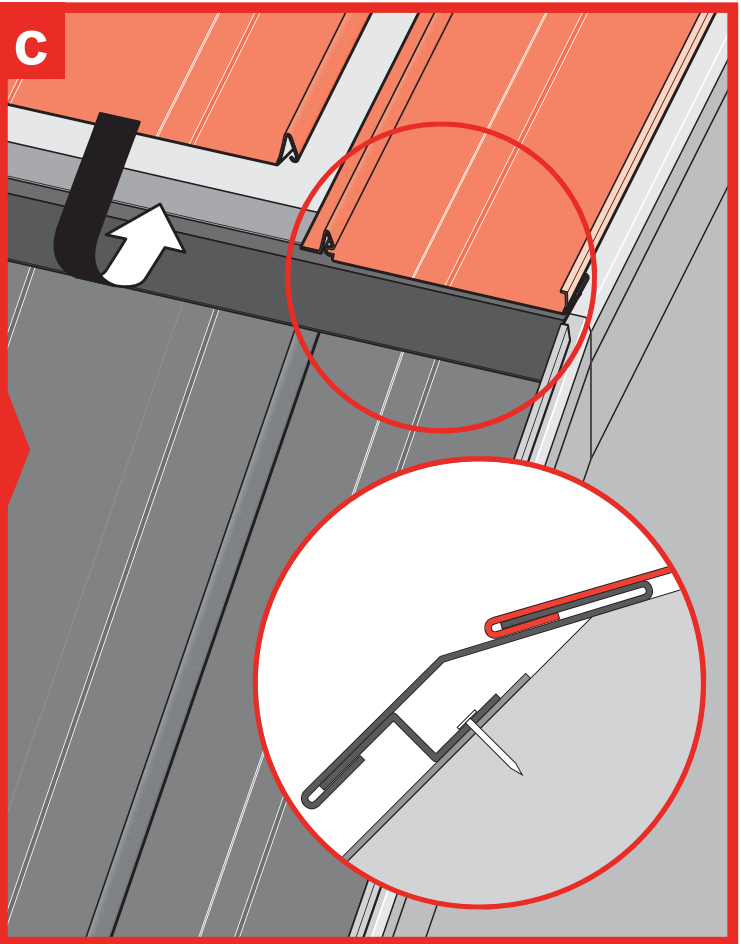

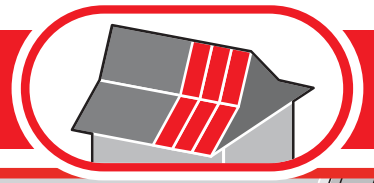

18

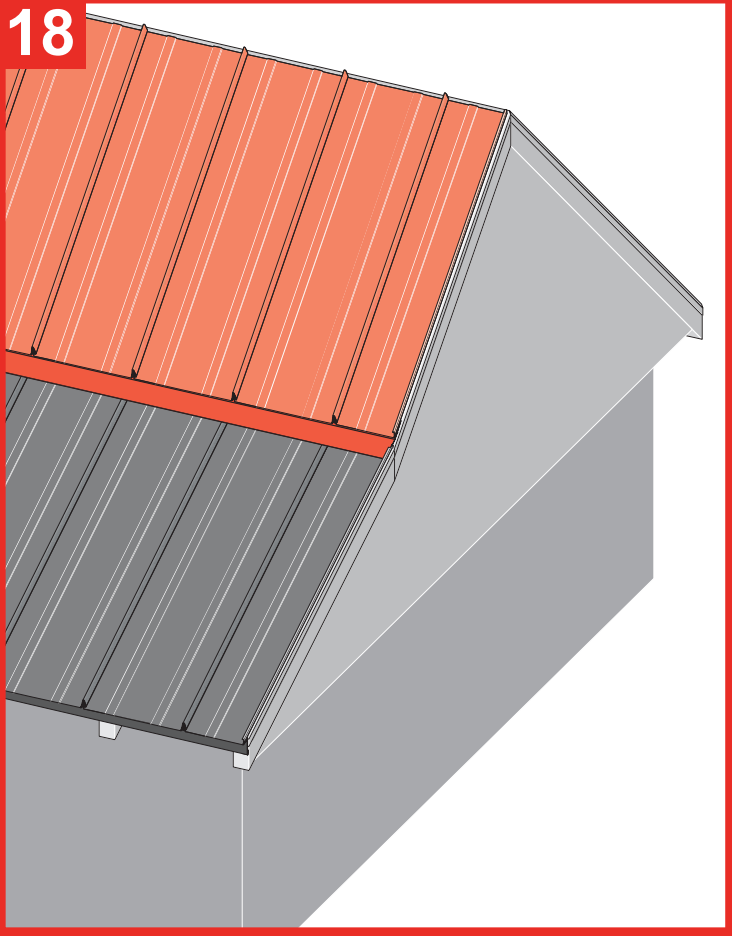

a

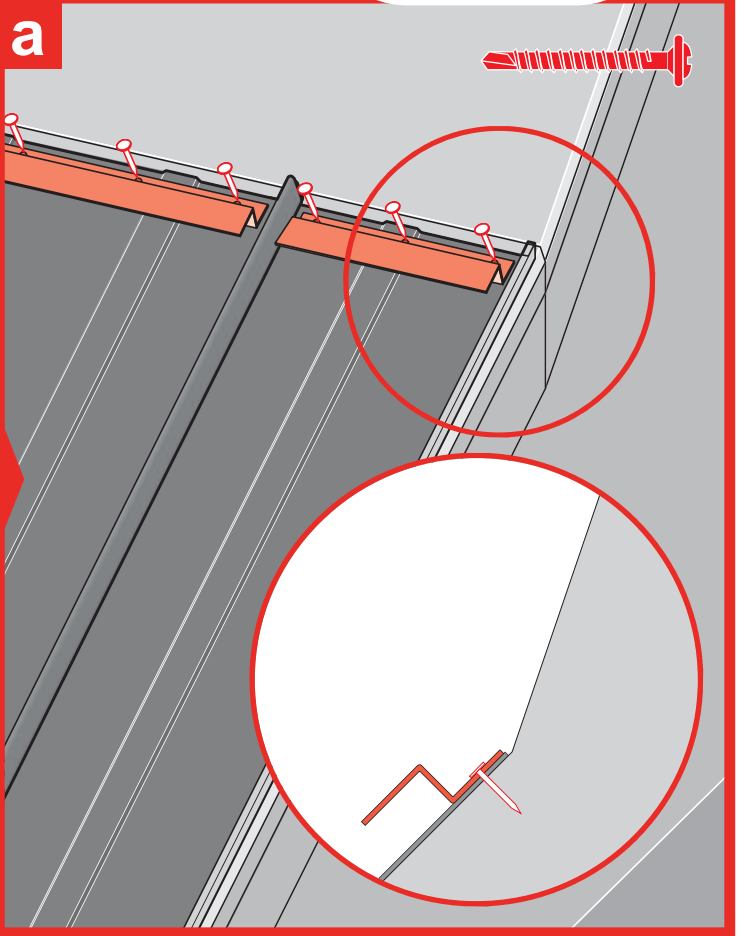

b

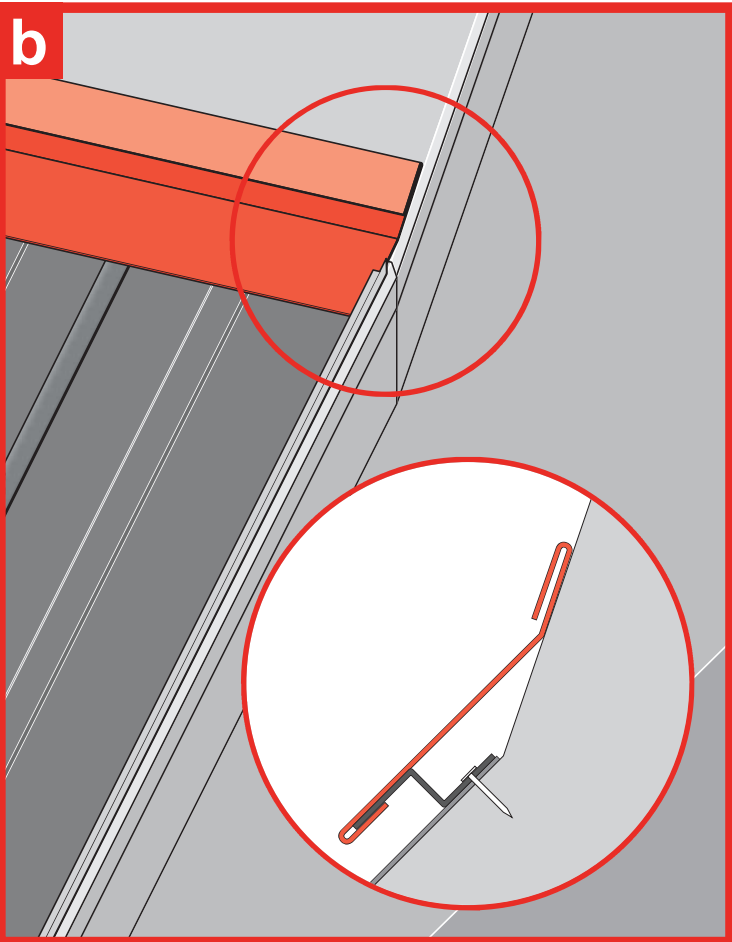

c

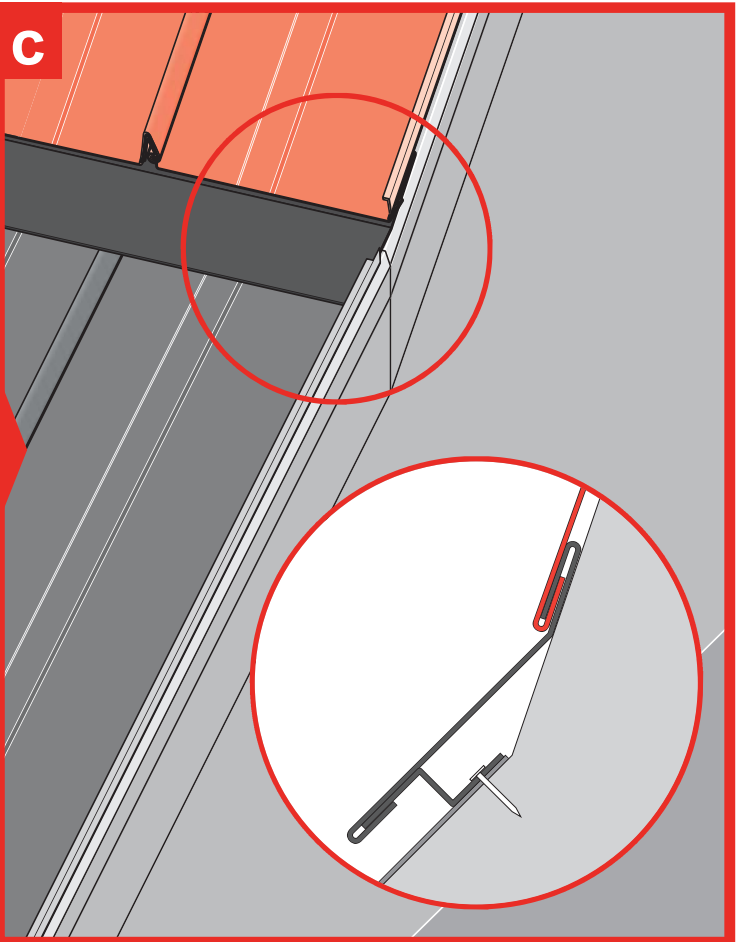

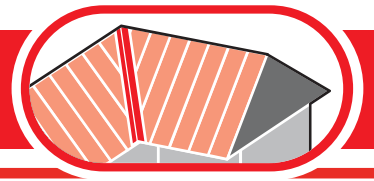

19

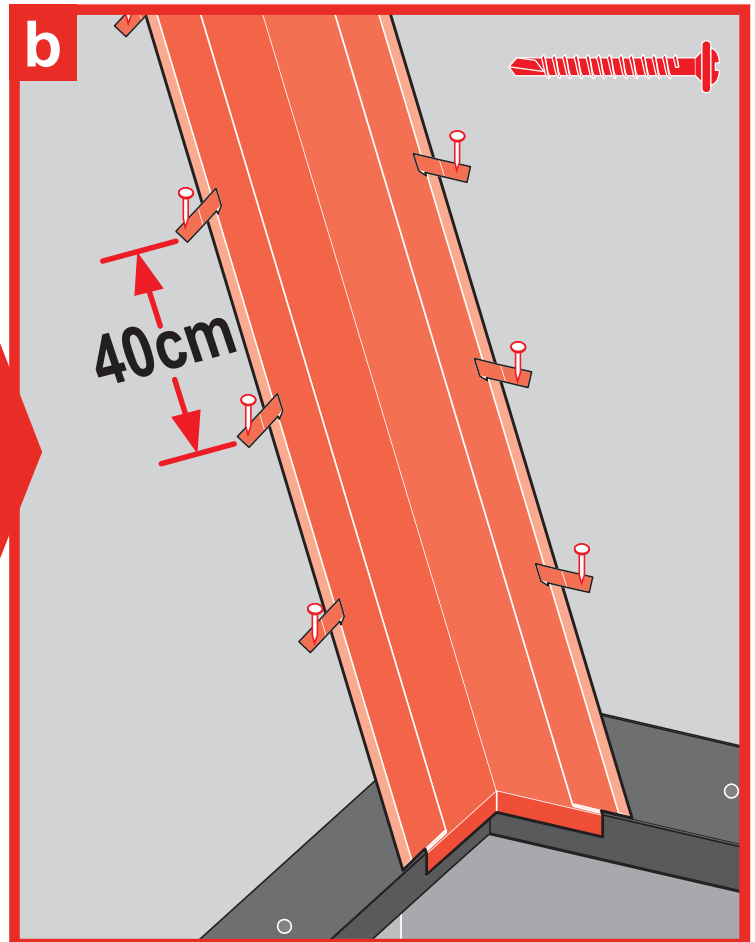
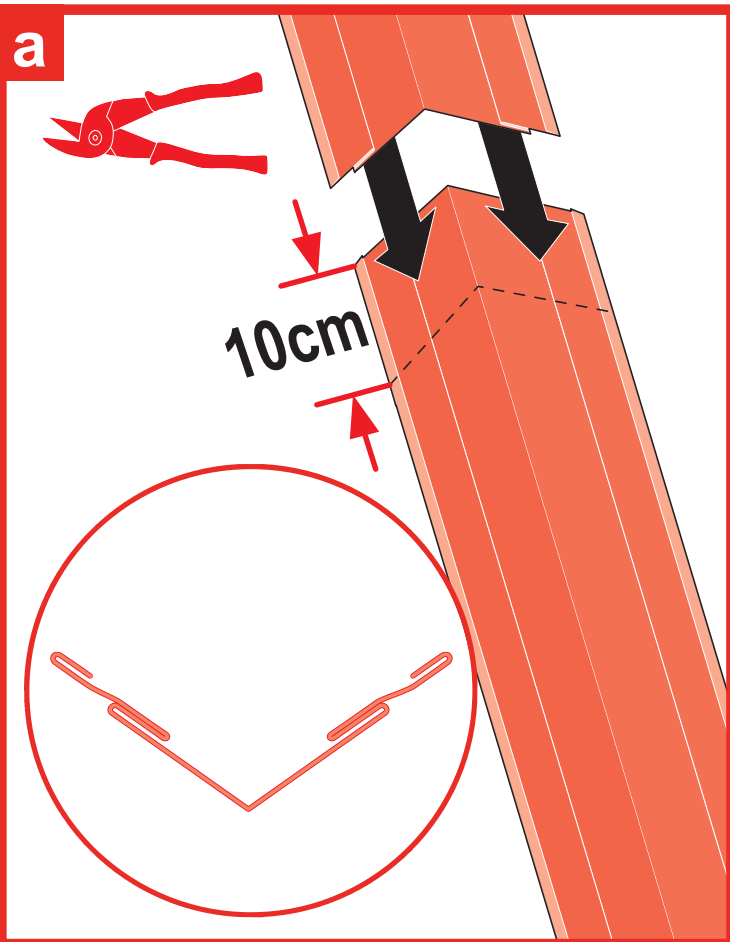
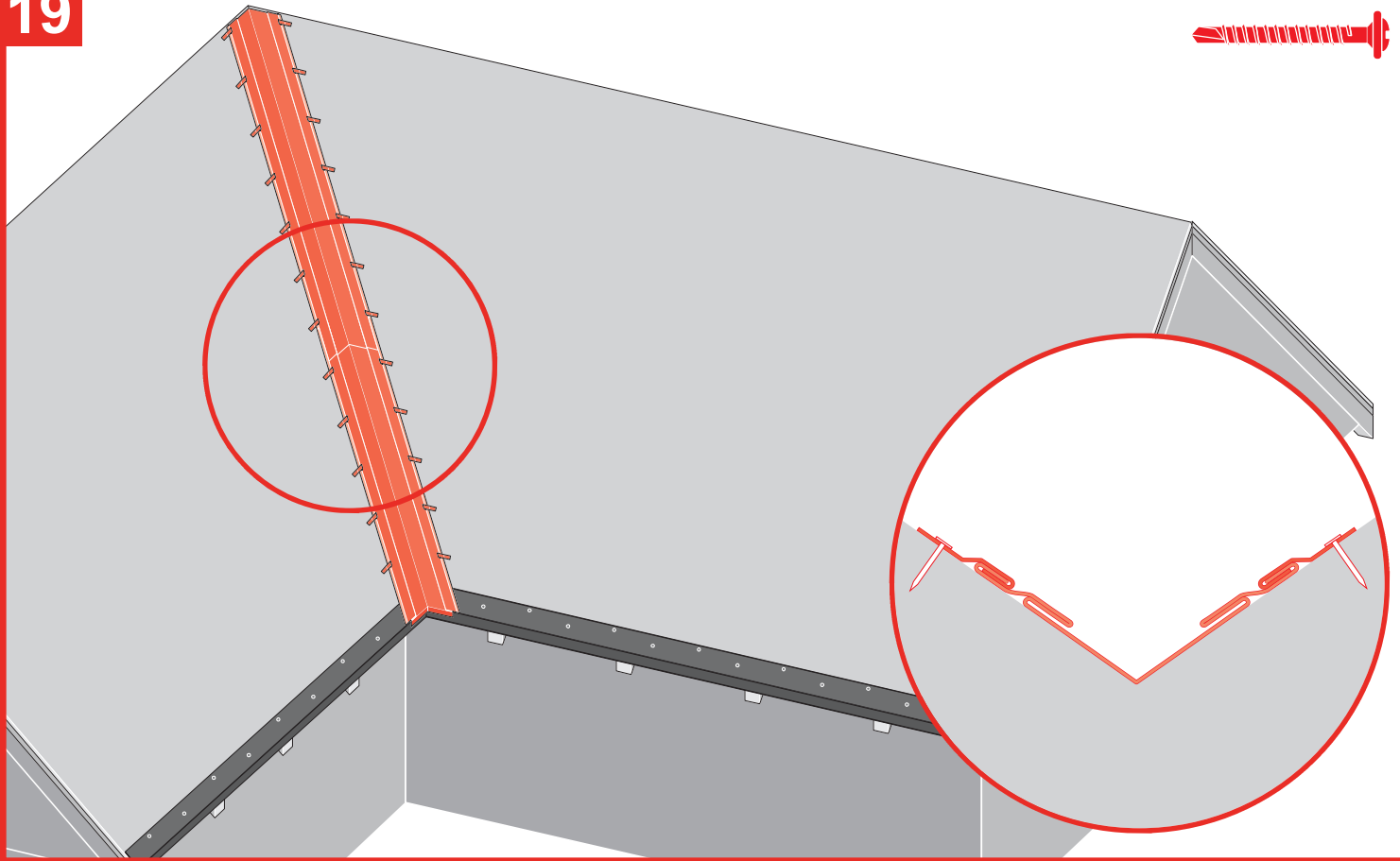

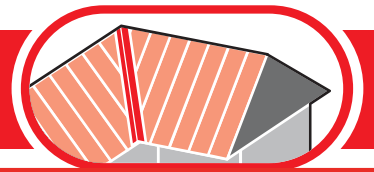

20

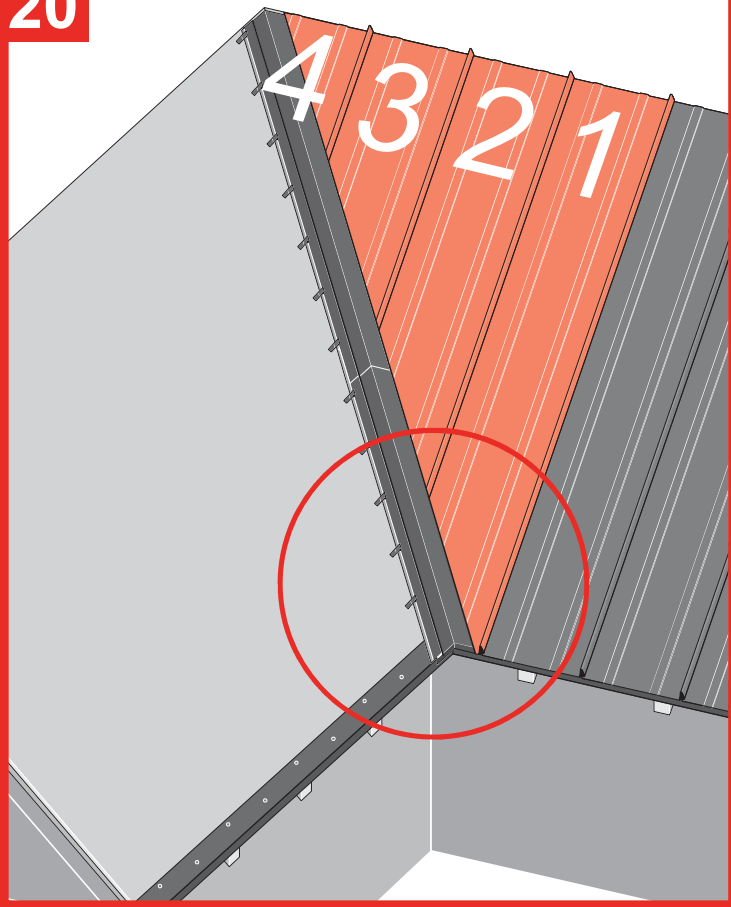

a

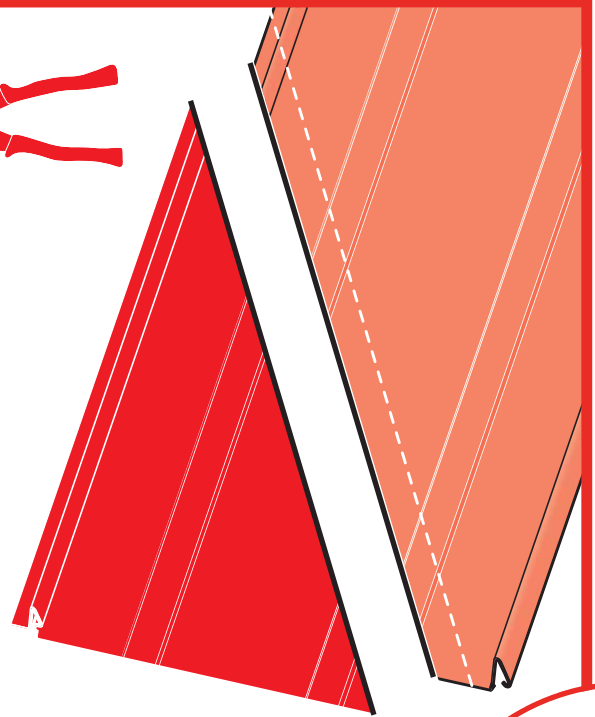
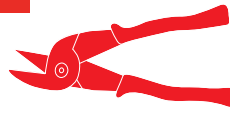

b

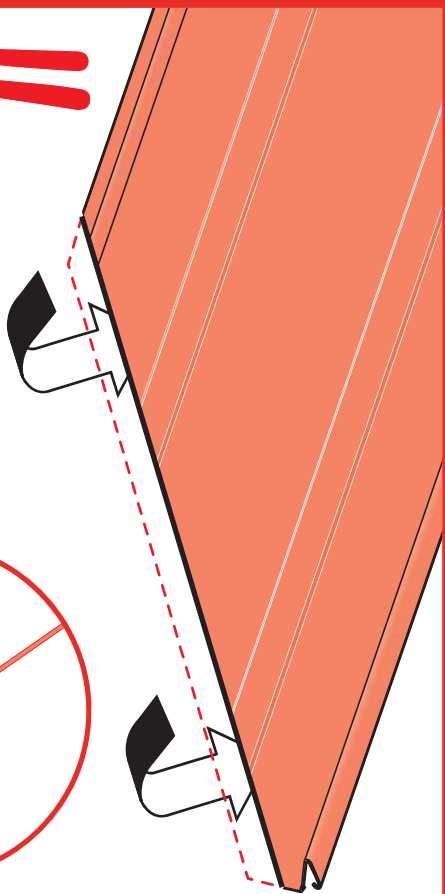
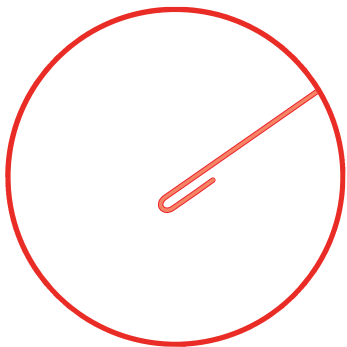

c

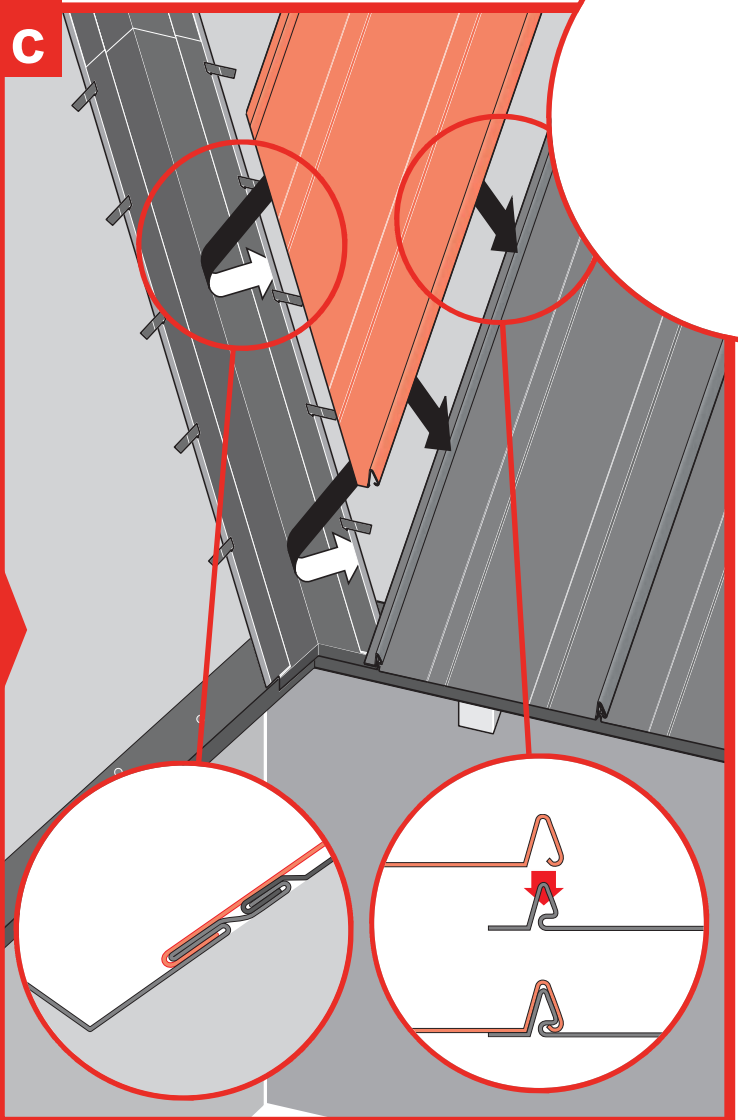

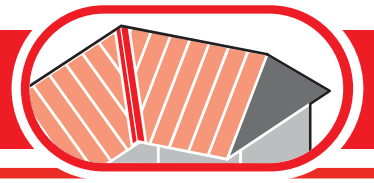

21

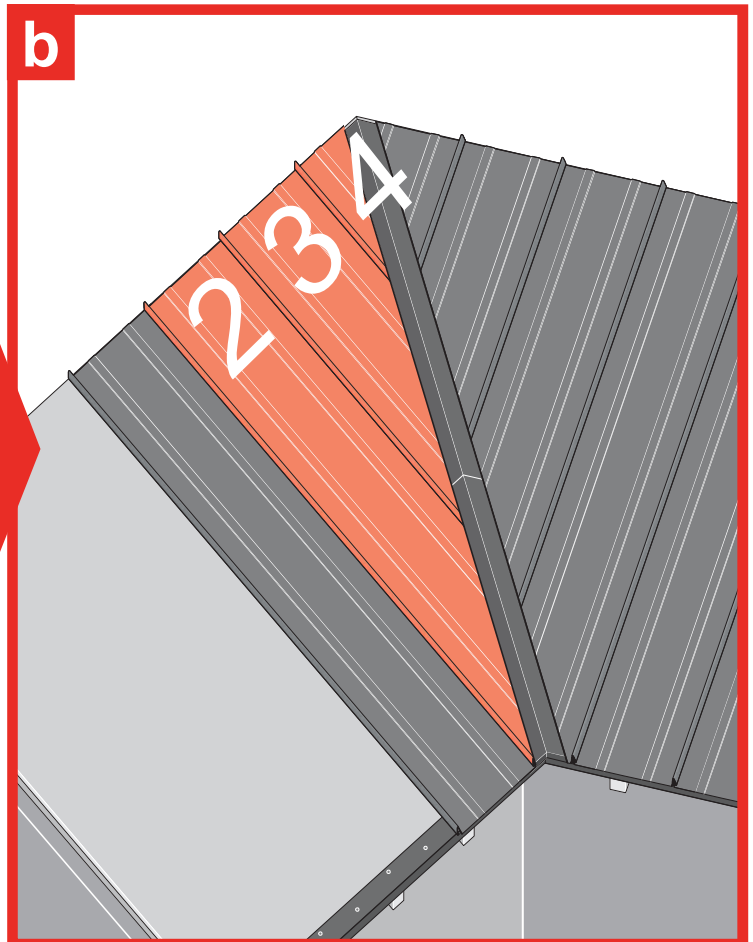
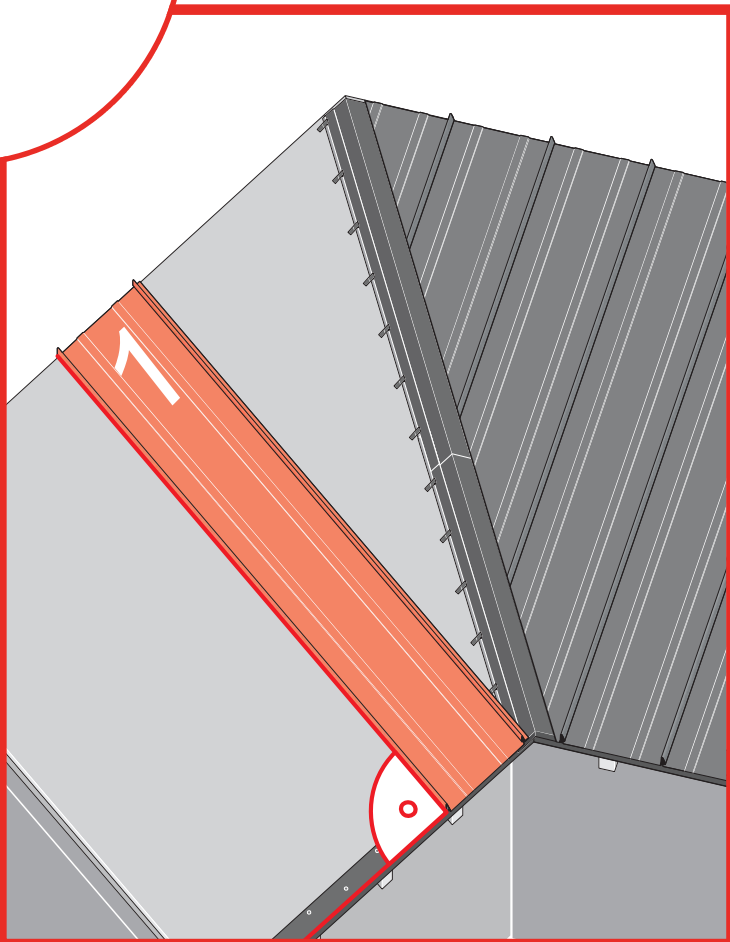
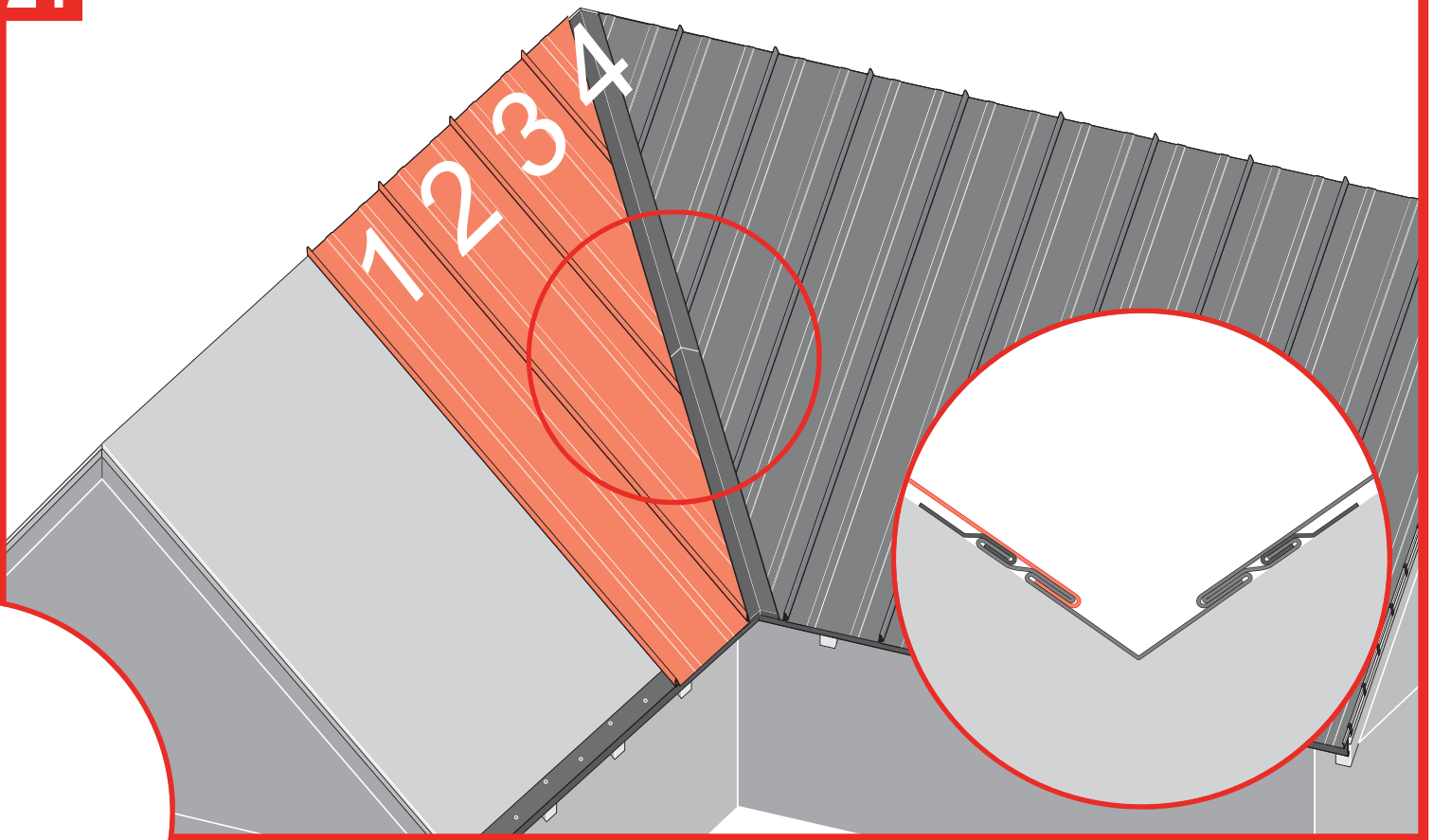

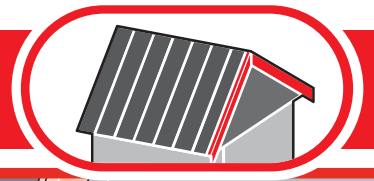

22

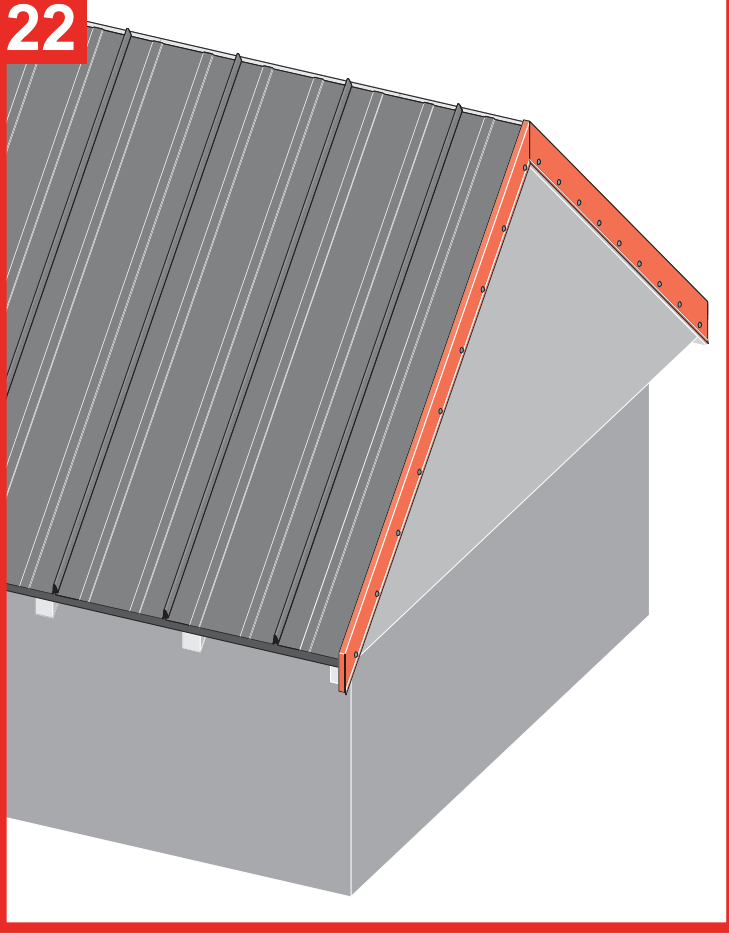

a

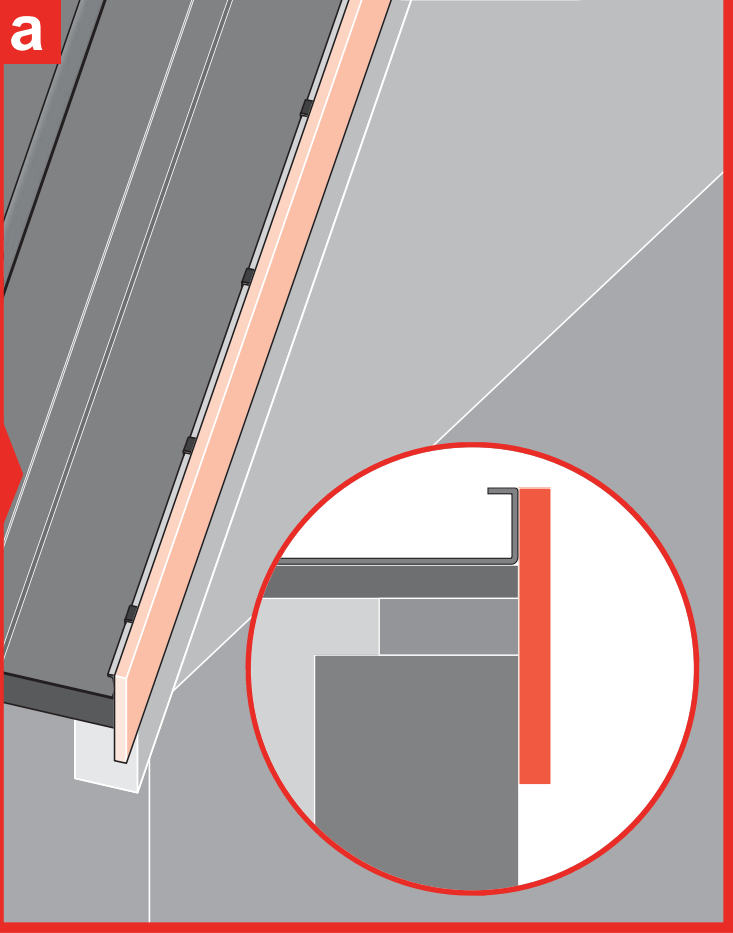

b

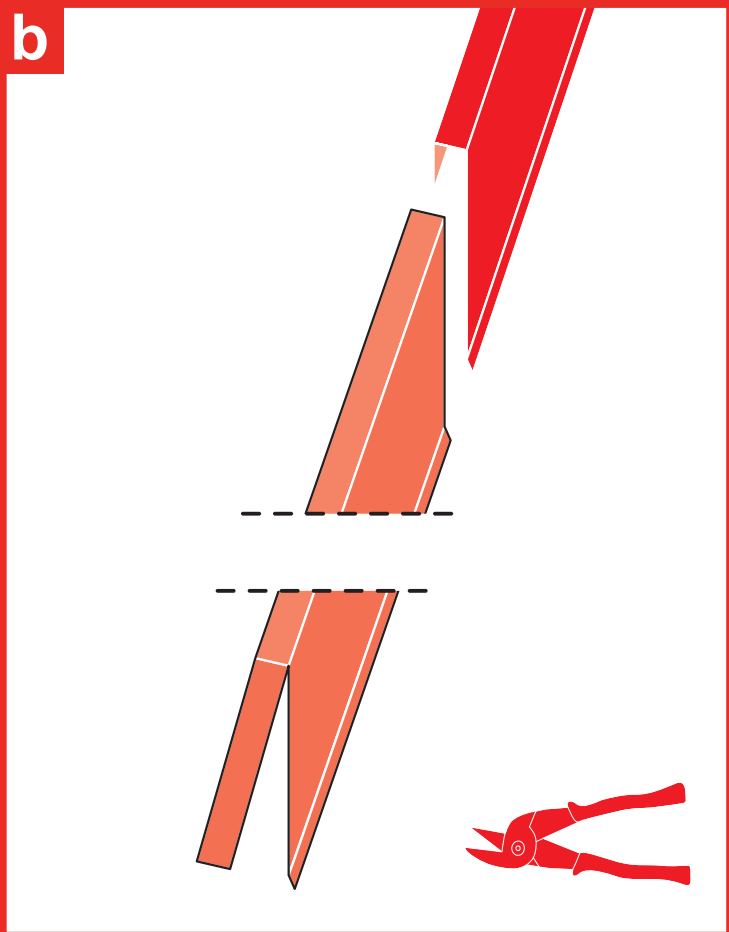

c

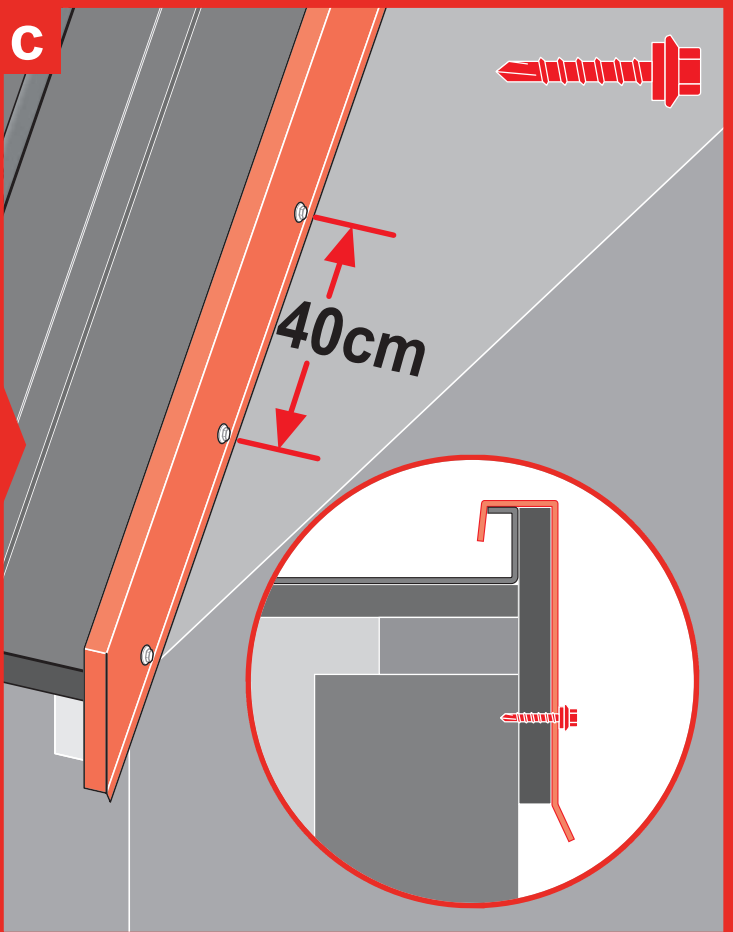

40cm

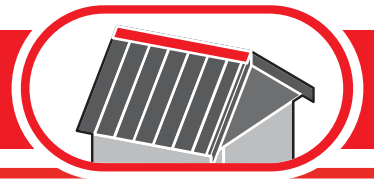

23

